

Xantrex™ XW MPPT 80 600 Solar Charge Controller

Operation Guide

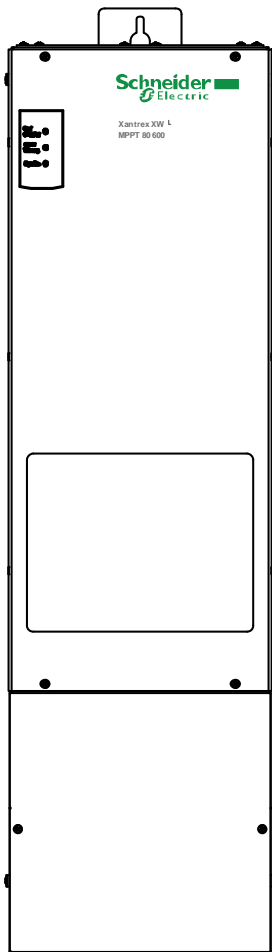

Xantrex XW MPPT 80 600 Solar Charge Controller

Operation Guide

Trademarks

Schneider Electric, the **Schneider Electric logo**, **Fast Sweep**, **Xanbus**, and **Xantrex** are trademarks or registered trademarks of the Schneider Electric group of companies. Other trademarks, registered trademarks, and product names are the property of their respective owners, and they are used herein for identification purposes only.

Notice of Copyright

Copyright © 2012, 2010 Schneider Electric SA. No part of this document may be reproduced in any form or disclosed to third parties without the express written consent of:

Schneider Electric SA
35 rue Joseph Monier
92500 Rueil Malmaison - France

This documentation may be revised and content hereof changed from time to time without obligation to notify any person or entity or to organize such revisions or changes unless required to do so by prior arrangement.

Exclusion for Documentation

UNLESS SPECIFICALLY AGREED TO IN WRITING, SELLER

(A) MAKES NO WARRANTY AS TO THE ACCURACY, SUFFICIENCY OR SUITABILITY OF ANY TECHNICAL OR OTHER INFORMATION PROVIDED IN ITS MANUALS OR OTHER DOCUMENTATION;





(B) ASSUMES NO RESPONSIBILITY OR LIABILITY FOR LOSSES, DAMAGES, COSTS OR EXPENSES, WHETHER SPECIAL, DIRECT, INDIRECT, CONSEQUENTIAL OR INCIDENTAL, WHICH MIGHT ARISE OUT OF THE USE OF SUCH INFORMATION. THE USE OF ANY SUCH INFORMATION WILL BE ENTIRELY AT THE USER'S RISK; AND

(C) REMINDS YOU THAT IF THIS DOCUMENT IS IN ANY LANGUAGE OTHER THAN ENGLISH, ALTHOUGH STEPS HAVE BEEN TAKEN TO MAINTAIN THE ACCURACY OF THE TRANSLATION, THE ACCURACY CANNOT BE GUARANTEED. APPROVED CONTENT IS CONTAINED WITH THE ENGLISH LANGUAGE VERSION WHICH IS POSTED AT WWW.SCHNEIDER-ELECTRIC.COM.

Document Part Number: 975-0560-01-01 **Revision:** B **Date:** January 2012

Contact Information

www.schneider-electric.com

			
North America	1 650 351 8237 1 866 519 1470	1 925 245 1022	re.techsupport@schneider-electric.com
France	+33 (0) 825 012 999		fr-re-techsupport@fr.schneider-electric.com
Deutschland	+49 (0) 180 575 3 575	+49 (0) 2102 404 7101	pv-service@de.schneider-electric.com
España	+34 902 101 813	+34 933 055 026	es-sat@es.schneider-electric.com
L'Italia	+39 035 4151111	+39 035415 3200	IT-pronto-contatto@it.schneider-electric.com

For other country details please contact your local Schneider Electric Sales Representative or visit the Schneider Electric Web site at:

<http://www.schneider-electric.com/sites/corporate/en/support/operations/local-operations/local-operations.page>

Information About Your System

As soon as you open your product, record the following information and be sure to keep your proof of purchase.

Serial Number _____

Product Number _____

Purchased From _____

Purchase Date _____

About This Guide

Purpose

This Guide provides explanations and procedures for configuring, operating, and troubleshooting the Schneider Electric Xantrex XW MPPT 80 600 Solar Charge Controller.

Scope

This Guide provides safety guidelines as well as information about operating, configuring, and troubleshooting the charge controller. It does not provide details about particular brands of photovoltaic (PV) panels or batteries.

Audience

This Guide is intended for anyone who operates the charge controller. Operators must be familiar with all the safety regulations pertaining to operating high-voltage equipment as dictated by local code. Operators must also have a complete understanding of this product's features and functions.

Only qualified personnel should perform the installation, configuration, commissioning, and maintenance of the charge controller. Qualified personnel have training, knowledge, and experience in:

- Installing electrical equipment and PV power systems (up to 1000 V).
- Applying all applicable installation codes.
- Analyzing and reducing the hazards involved in performing electrical work.
- Selecting and using personal protective equipment.

Do not use this charge controller unless it has been installed by qualified personnel in accordance with the instructions in the Xantrex XW MPPT 80 600 Solar Charge Controller Installation Guide (Document Part Number 975-0540-01-01).

Organization

This Guide is organized into the following chapters and appendices:

- Chapter 1 describes features and functions of the charge controller.
- Chapter 2 contains information and procedures to configure the charge controller.
- Chapter 3 contains information about operating the charge controller.
- Chapter 4 contains information about identifying and resolving possible problems that might arise while using a charge controller.

- Appendix A provides the specifications for the charge controller.
- Appendix B is a guide to the charge controller's monitoring and configuration menus on the Xantrex XW System Control Panel.
- Appendix C provides information on Boost Charging for flooded lead-acid batteries in off-grid applications.

Conventions Used

This Guide uses the term “charge controller” to refer to the Xantrex XW MPPT 80 600 Solar Charge Controller.

This Guide uses the following conventions for conveying important safety related information:

⚠ DANGER

DANGER indicates an imminently hazardous situation which, if not avoided, will result in death or serious injury.

⚠ WARNING

WARNING indicates a potentially hazardous situation which, if not avoided, can result in death or serious injury.

⚠ CAUTION

CAUTION indicates a potentially hazardous condition which, if not avoided, can result in minor or moderate injury.

CAUTION

CAUTION without the exclamation symbol indicates a potentially hazardous situation, which, if not avoided, can result in equipment damage.

NOTICE

NOTICE indicates important information that you need to read carefully.

Abbreviations and Acronyms

CEC	Canadian Electric Code
CSA	Canadian Standards Association
DC	Direct Current
FCC	Federal Communications Commission
GFP	Ground Fault Protection
I_{MP}	Current at maximum power per STC
I_{SC}	Short circuit current rating of an PV panel under STC
LCD	Liquid Crystal Display
LED	Light Emitting Diode
MPP	Maximum Power Point
MPPT	Maximum Power Point Tracking
MSDS	Material Safety Data Sheet
NFPA	National Fire Protection Association
PDP	Xantrex XW Power Distribution Panel
PV	Photovoltaic
SCP	System Control Panel
STC	Standard Test Conditions specific to photovoltaic panels (1000 W/m ² , light spectrum AM 1.5 and 25 °C); panel nameplate ratings are based on STC and may be exceeded under other conditions.
UL	Underwriters Laboratories
VAC	Volts AC
VDC	Volts DC
V_{MP}	Voltage at maximum power per STC
V_{OC}	Open circuit voltage rating of a PV panel under STC

Related Information

You can find information about installing the charge controller in the Xantrex XW MPPT 80 600 Solar Charge Controller Installation Guide (Document Part Number 975-0540-01-01). It is provided with the charge controller and is also available at www.schneider-electric.com.

You can find more information about Schneider Electric as well as its products and services at www.schneider-electric.com.

Important Safety Instructions

This Guide contains important safety instructions that must be followed during the installation and maintenance of the charge controller. Make sure you read, understand, and save these safety instructions.

⚠ DANGER

HAZARD OF SHOCK, BURN, FIRE, AND EXPLOSION

- The charge controller must be installed and serviced only by qualified personnel equipped with appropriate personal protective equipment and following safe electrical work practices.
- The charge controller is energized from multiple sources. Before removing the covers, consult the system diagram to identify all sources; de-energize, lock out, and tag out; and wait for two minutes for internal capacitors to discharge to a safe voltage.
- Before servicing the charge controller, test using a meter rated at least 1000 VDC to make sure all circuits are de-energized.
- The charge controller is provided with integral PV ground fault protection. Normally grounded conductors could be ungrounded and energized when a ground fault is indicated. The integral ground fault detection fuse is located under the wiring compartment cover. Disconnect all sources of power before opening the cover.

Failure to follow these instructions will result in death or serious injury.

⚠ WARNING

LIMITATIONS ON USE

Do not use the charge controller with life support equipment or other medical equipment or devices.

Failure to follow these instructions can result in death or serious injury.

⚠ WARNING

HAZARD OF ELECTRIC SHOCK

For installation indoors only. Do not expose the charge controller to rain, snow, dust, or liquids of any type.

Failure to follow these instructions can result in death or serious injury.

Personal Protection

Follow these instructions to help protect yourself while working with the charge controller.

⚠ DANGER

HAZARD OF ELECTRIC SHOCK AND BURN

Thoroughly inspect the charge controller prior to energizing. Verify that no tools or materials have been inadvertently left behind.

Failure to follow these instructions will result in death or serious injury.

Installation personnel must be equipped with adequately rated personal protective equipment as per local safety regulations and applicable workplace safety procedures.

Battery Safety Information

⚠ DANGER

HAZARD OF ELECTRIC SHOCK, BURN, FIRE, AND EXPLOSION

Batteries contain corrosive electrolyte and can give off explosive gases. Battery circuits present a shock and energy hazard. Observe proper precautions when working with batteries and battery circuits, including:

- Always wear eye protection when working with batteries.
- Remove all jewelry before performing electrical work.
- Install batteries in a well-ventilated area to help prevent the possible buildup of explosive gases.
- Do not mix battery types.
- Do not smoke in the vicinity of a battery.
- Use insulated tools when working with batteries.
- When connecting batteries, always verify proper voltage and polarity.
- Do not short-circuit the battery.
- Always use proper lifting techniques when handling batteries.

Failure to follow these instructions will result in death or serious injury.

For full installation instructions and safety information, see the documentation provided with the batteries. Consult the MSDS for the batteries for first aid procedures, emergency procedures, and clean-up instructions.

FCC Information to the User

This charge controller has been tested and found to comply with the limits for a Class B digital device, pursuant to part 15 of the FCC Rules and Industry Canada ICES-003. These limits are designed to provide reasonable protection against harmful interference when the charge controller is operated in a residential environment. This charge controller generates, uses, and can radiate radio frequency energy and, if not installed and used in accordance with the installation and operation guides, could cause harmful radio frequency interference with radio communications. However, there is no guarantee that interference will not occur in a particular installation. If this charge controller does cause harmful interference with radio or television reception, which can be determined by turning the charge controller off and on, try to correct the interference by one or more of the following measures:

- Reorient or relocate the receiving antenna.
- Increase the separation between the charge controller and the receiver.
- Connect the charge controller to a different circuit from that to which the receiver is connected.
- Consult the dealer or an experienced radio or TV technician for help.

Contents

Important Safety Instructions-----vii

1 Introduction

Features	1-2
Maximum Power Point Tracking	1-3
Fast Sweep™ Shade Tolerant MPPT Algorithm	1-3
Charge Controlling	1-4
Three-Stage Battery Charging	1-4
Bulk Stage	1-4
Absorption Stage	1-4
Float Stage	1-5
Two-Stage Battery Charging	1-6
Battery Temperature Compensation	1-7
Equalization Charging	1-8
Auxiliary Output Functions	1-9

2 Configuration

Configuring the Unit	2-2
Selecting a Unit	2-2
Viewing Basic and Advanced Settings	2-2
Modifying Configurable Settings	2-3
Configuring Battery Characteristics and Battery Charging	2-3
Setting a Custom Battery Type	2-6
Battery Temperature Compensation	2-7
Configuring Peak Power Tracking	2-7
Configuring the Auxiliary Output	2-8
Trigger Source Descriptions	2-11
Trigger Source Configurable Ranges	2-12
Configuring Device Settings	2-13
Reducing Tare Loss	2-16
Resetting to Factory Defaults	2-16

3 Operation

Viewing Status Information on the Charge Controller	3-2
Viewing Status on the SCP	3-3
Normal Operation	3-3
Charge Stages	3-4

Contents

Viewing Active Faults, Errors, and Warnings-----	3-4
Faults -----	3-6
Errors -----	3-7
Warnings -----	3-9
Viewing Fault, Error, and Warning Logs -----	3-11
Viewing Harvest Logs-----	3-11
Daily Logs -----	3-12
Monthly Logs -----	3-12
Yearly Logs -----	3-12
Equalizing Batteries -----	3-12
4 Troubleshooting	
Troubleshooting-----	4-2
A Specifications	
Electrical Specifications -----	A-2
MPPT Voltage Range -----	A-3
Operating Below the PV Array Voltage Full Power Range -----	A-3
Default Battery Charging Settings -----	A-5
Mechanical Specifications -----	A-5
Output Power Versus Ambient Temperature-----	A-6
Accessories-----	A-6
Regulatory Approvals-----	A-7
B Xantrex XW System Control Panel Menus	
Using the SCP -----	B-2
SCP Menu Map -----	B-3
Changing Settings Using the SCP -----	B-4
Viewing the Select Device Menu -----	B-5
Viewing the Setup Menu -----	B-5
The Setup Menu-----	B-6
Configuration Settings -----	B-7
Monitoring the Unit-----	B-10
Home Screen -----	B-10
Meters -----	B-11
C Boost Charging	
Using Boost Charging -----	C-2
Index -----	IX-1

1

Introduction

Chapter 1 describes features and functions of the charge controller.

For information on:	See:
"Features"	page 1-2
"Maximum Power Point Tracking"	page 1-3
"Fast Sweep™ Shade Tolerant MPPT Algorithm"	page 1-3
"Charge Controlling"	page 1-4
"Auxiliary Output Functions"	page 1-9

Features

This photovoltaic charge controller tracks the maximum power point of a PV array to deliver the maximum available current for optimum charging of batteries. The charge controller can be used with 24 and 48 VDC battery systems only.

The charge controller is designed to regulate the available power from a PV source only. It is not designed to regulate power from other types of power sources.

The charge controller can be installed (in single or multi-unit configurations) with a Xantrex XW Hybrid Inverter/Charger or as a stand alone battery charger. However, it is recommended that—at minimum—an SCP or Xantrex Gateway be included in the system (see “Accessories” on page A-6 for product part numbers). The System Control Panel (SCP) provides both status information and the ability to change settings, while the Gateway (access via a personal computer) provides status information only. An SCP is required for installation of the charge controller.

Standard features of the charge controller include:

- Two- or three-stage charging process, with manual equalization to maximize system performance and maintain expected battery life.
- Maximum Power Point Tracking (MPPT) to deliver the maximum available power from a PV array to a bank of batteries. See “Maximum Power Point Tracking” on page 1-3.
- Integrated PV Ground Fault Protection (PV GFP).
- Fan-cooled with speed control based on internal (heat sink) temperature.
- 80 amp charging current capability.
- Configurable auxiliary output. See “Auxiliary Output Functions” on page 1-9.
- Three LEDs for displaying operating status (On/Charging, Equalize, and Error/Warning).
- Input over-voltage protection, output over-voltage protection, output under-voltage protection, and output over-current protection. Warnings, errors, and faults are indicated by the red LED. View the associated warning or error message on the SCP.
- Xantrex Xanbus™-enabled. Xanbus is a network communications protocol developed by the manufacturer. The charge controller is able to communicate its settings and activity to other Xanbus-enabled devices, such as the Xantrex XW Hybrid Inverter/Charger, the SCP, the Xantrex XW Automated Generator Start, and other charge controllers.
- Over-temperature protection and power derating of output power when ambient temperature is high.
- Battery Temperature Sensor (BTS) to provide automatic temperature-compensated voltage setpoints for battery charging. If the BTS is lost or damaged, you can order a replacement from the manufacturer (part number 808-0232-02).

Maximum Power Point Tracking

MPPT allows the charge controller to harvest the maximum energy available from the PV array and deliver it to the batteries. The MPPT algorithm continuously adjusts the operating voltage of the array to find the maximum power point. Input power is measured and compared to the amount of input power harvested at the previous operating voltage. The next adjustment to the operating voltage is dependent upon whether the charge controller harvested more or less power than it did at the previous operating voltage.

The algorithm is implemented by applying a variable load on the array—shown by the power curve (solid line) in Figure 1-1—until it finds the peak power (the point at which the combination of the operating voltage and current is maximized), as indicated by **MPP** in Figure 1-1. The charge controller will continue adjusting the operating voltage to stay on the maximum power point. This is necessary as **MPP** changes throughout the day due to panel temperature, panel shading, and sunlight intensity. The adjustments happen without interruption of output power flow to the batteries.

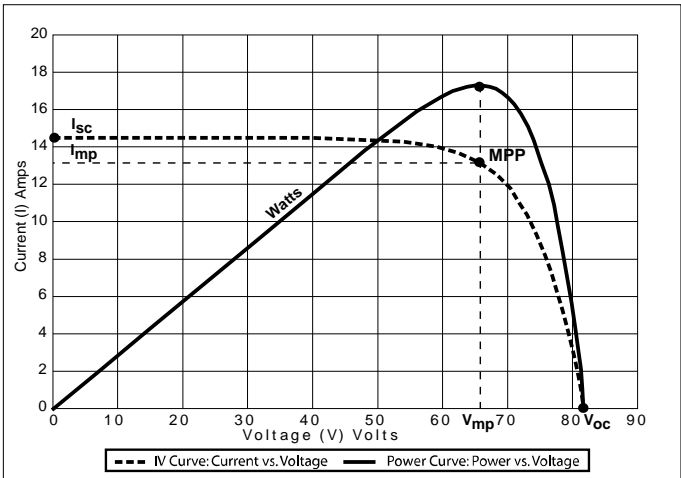

Figure 1-1 Maximum power point curve

Fast Sweep™ Shade Tolerant MPPT Algorithm

The charge controller has a Fast Sweep MPPT algorithm that frequently conducts a very fast sweep of the full operational array voltage window to dynamically determine the array’s maximum power point. This feature helps deliver consistently high energy harvest for the system, including when the array is partially shaded. For more information on shade-tolerant MPPT optimization, see the white paper, “Photovoltaic String Inverters and Shade-Tolerant Maximum Power Point Tracking: Toward Optimal Harvest Efficiency and Maximum ROI,” available at <http://www.se-renbu-docs.com/SEShadeTolerantWP.pdf>.

Charge Controlling

The charge controller can regulate PV array current at an appropriate level for 24 or 48 V batteries. It produces up to 80 amps of charging current for both battery voltages up to 2560 watts (24 V) or 4800 watts (48 V).

The charge controller controls how the batteries are charged by the PV array. It can be configured to use a two-stage (no float) or three-stage charging process to maintain battery voltage at bulk, absorption, or float levels. When charging, the charge controller regulates the battery voltage and the output current based on the amount of DC power available from the PV array and the state of charge of the battery.

Three-Stage Battery Charging

The three-stage battery charging process results in more efficient charging compared to on-off relay type or constant voltage solid-state regulators. The final float stage reduces battery gassing, minimizes electrolyte loss, and ensures complete battery recharging. Battery voltage and current vary during the three-stage charging process as shown in Figure 1-2 on page 1-5.

Bulk Stage

During the bulk stage, the charge controller operates in constant current mode, delivering the maximum current to the batteries (or the maximum current available if the PV does not have enough power to provide maximum current). Once the battery voltage reaches the absorption voltage setting, the charge controller transitions to the absorption stage.

Absorption Stage

During the absorption stage, the charge controller begins operating in constant voltage mode and the current falls gradually as the amp hours are returned to the battery. The voltage limit used for the first 60 minutes of this stage is the bulk voltage setting. The voltage limit used for the remaining time in this stage is the absorption voltage setting. By default, the bulk voltage setting and the absorption voltage setting are the same for all battery types.

The default voltage limit settings (bulk and absorption) can be adjusted if the battery type is set to Custom (see “Setting a Custom Battery Type” on page 2-6). For flooded lead acid batteries only, you can use a custom charging scheme which sets the bulk voltage higher than the absorption voltage. The result of this is a boost voltage charge level that has been found to be beneficial for ensuring enough amp hours are returned to the battery bank for off-grid installations. For detailed information on how boost charging works and when it is recommended, see Appendix C, “Boost Charging”.

The charge controller transitions to the float stage if either of the following two conditions are met:

- The charge current allowed by the batteries falls below the exit current threshold, which is equal to 2% of the programmed battery capacity (for a 500 amp-hour battery bank, this would be 10 amps), for one minute.
- The charge controller has been in absorption for the programmed maximum absorption time limit. The default is three hours, but the time limit is programmable from one minute to eight hours.

Float Stage

During the float stage, the voltage of the battery is held at the float voltage setting. Full current can be provided to the loads connected to the battery during the float stage from the PV array. When battery voltage drops below the recharge voltage setting for one minute, a new bulk cycle is triggered.

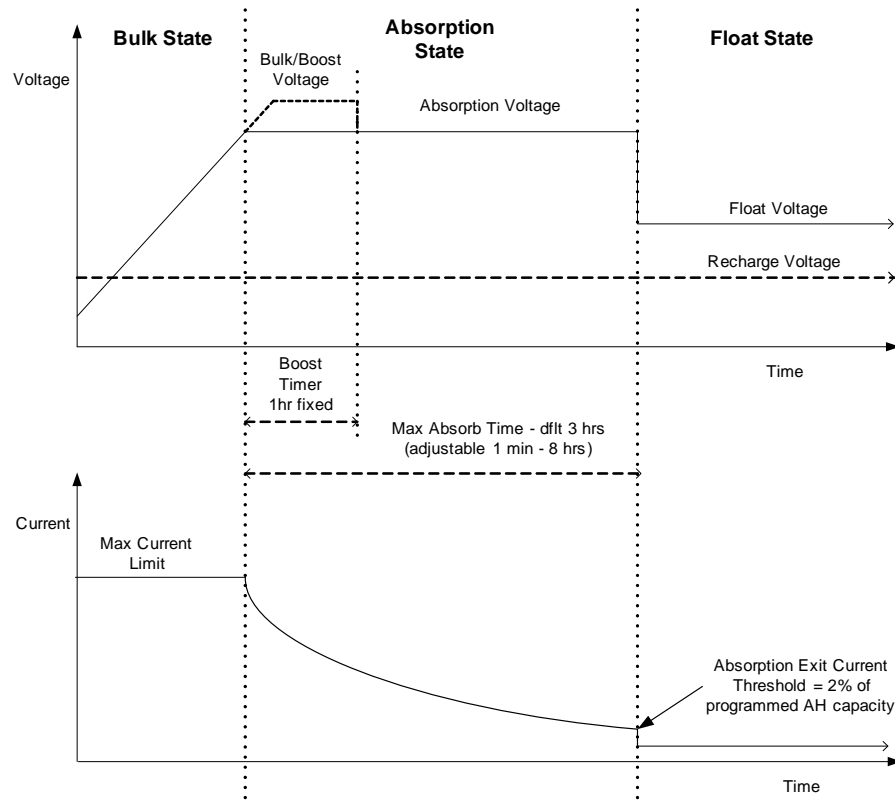

Figure 1-2 Three-stage battery charging cycle^a

a. The charging cycle of the charge controller might differ from the curves shown above due to the amount of solar energy available and any DC loads present on the battery system during charge.

NOTICE

This notice is applicable to Figure 1-2 and Figure 1-3.

- When the charge cycle is interrupted, the charge controller will resume charging at the beginning of the multi-stage algorithm.
- The exit current threshold mechanism can be disabled by setting the amp-hour capacity to 0. In this case, absorption will only exit when the absorption timer expires.
- Charge current during the equalize state (an optional state not shown in the figures) is normally limited to 10% of the programmed amp-hour capacity setting. If this setting is programmed to 0 Ah, the charge current during equalize is limited to what is programmed for the maximum current limit of the charge controller (default is 80 A).
- Synchronized charge states are active when more than one charging device (the charge controller or Xantrex XW Hybrid Inverter/Charger) is connected in the battery system and a common Xanbus network.
 - The first charging device to enter bulk causes all other devices to enter bulk.
 - The first charging device to enter absorption causes all other devices to enter absorption.
 - The last Xantrex XW Hybrid Inverter/Charger that is ready to exit absorption triggers all devices to exit absorption and enter float.

Two-Stage Battery Charging

The two-stage charging process includes the bulk and absorption stages only. There is not a float stage. The relationship between charging current and battery voltage during the two-stage charging process is shown in Figure 1-3.

No Float State

During the no float state the charge controller does not produce any charge current. Instead, the charge controller monitors the battery voltage and transitions back to the bulk stage once the voltage drops below the recharge voltage setting for one minute.

NOTICE

For more information about battery charging settings, see Table 2-1, "Battery configuration settings" on page 2-4 and Table 2-2, "Custom battery settings" on page 2-6.

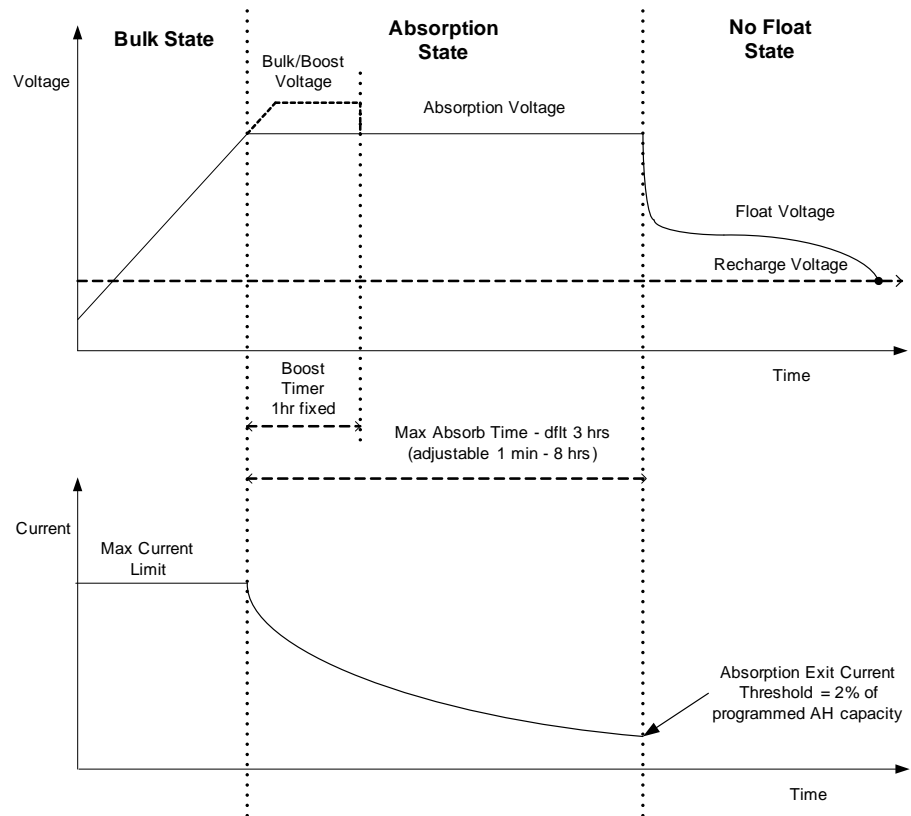

Figure 1-3 Two-stage battery charging cycle

Battery Temperature Compensation

The Battery Temperature Sensor (BTS) provides temperature-compensation for battery charging. With the BTS installed, the charge controller adjusts charging voltage with the temperature of the battery to optimize the charge delivery and help prolong battery life. The BTS also provides over-temperature protection for the batteries.

The BTS plugs into the BTS RJ-11 port located inside the wiring compartment of the charge controller. The BTS can be installed on the negative battery post, positive battery post, or side of the battery case. See "Installing the Battery Temperature Sensor" in the Xantrex XW MPPT 80 600 Solar Charge Controller Installation Guide (Document Part Number 975-0540-01-01).

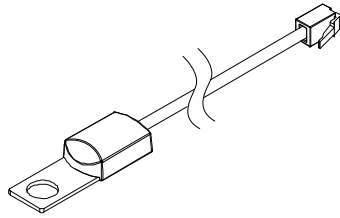

Figure 1-4 Battery temperature sensor

If a BTS is not installed, the voltage settings for charging are based on one of three temperature settings (Cold, Warm, or Hot) available on the Charger Settings menu. See “Configuring Battery Characteristics and Battery Charging” on page 2–3.

If multiple charge controllers or a complete Xantrex XW Power System with Xantrex XW Hybrid Inverter/Chargers are networked together using Xanbus, then only one BTS is required per battery bank. All networked Xantrex XW Series devices share battery temperature information, and you can connect the BTS to a charge controller or a Xantrex XW Hybrid Inverter/Charger. If more than one BTS is used within the system, then the highest reported temperature from all of the units with an attached BTS will be used as the battery temperature for the temperature compensation value of the battery charge algorithm.

Equalization Charging

The charge controller can provide the battery bank with an equalization charge. Equalization is a deliberate overcharge designed to return each battery cell to optimum condition by reducing sulfation and stratification in the battery. The equalization charge is generally performed only on flooded, vented (non-sealed or “wet”) lead-acid batteries, as recommended by the battery manufacturer.

CAUTION
BATTERY DAMAGE To avoid damaging your batteries be sure to read, understand, and follow all cautions and warnings concerning equalization charging. For more information, see “Equalizing Batteries” on page 3–12. Failure to follow these instructions can result in equipment damage.

Auxiliary Output Functions

The charge controller has a set of auxiliary relay contacts—one normally opened (NO) and one normally closed (NC)—that can be used to drive a relay for load control or to turn on devices such as vent fans or indicator alarms. The auxiliary output can be configured to trigger under only one condition at a time. See “Configuring the Auxiliary Output” on page 2–8 for information about auxiliary output trigger sources and how to enable and configure the auxiliary output for your application.

Load Control

The charge controller’s auxiliary output can be configured to disconnect or reconnect loads depending on battery voltage. This load control function enables the charge controller to help prevent damage to the battery from over-discharge during periods of poor charging (due to ambient temperature, for example) or excessive loads.

Vent Fan

The charge controller’s auxiliary output can be configured to trigger a small DC fan to clear a battery compartment of harmful gases. The charge controller’s auxiliary output must be configured to activate when flooded batteries reach their gassing voltage.

Alarms

The auxiliary output can be configured to trigger an alarm or indicator light when a pre-set condition occurs, such as low or high battery voltage, high PV array voltage, or a charge controller error condition.

2

Configuration

Chapter 2 contains information and procedures to configure the charge controller.

For information on:	See:
"Configuring the Unit"	page 2-2
"Configuring Battery Characteristics and Battery Charging"	page 2-3
"Configuring Peak Power Tracking"	page 2-7
"Configuring the Auxiliary Output"	page 2-8
"Configuring Device Settings"	page 2-13
"Reducing Tare Loss"	page 2-16
"Resetting to Factory Defaults"	page 2-16

Configuring the Unit

Configure the charge controller using the SCP. See Appendix B, “Xantrex XW System Control Panel Menus” for an overview of the SCP, or download the entire SCP Owner’s Guide (Document Part Number 975-0298-01-01) at www.schneider-electric.com.

Selecting a Unit

Before you can configure the charge controller’s settings, you must select the charge controller’s device number in the SCP by performing the following steps:

1. On the `System Status` home screen, press `Enter`.
The `Select Device` menu opens.
2. Use the arrow buttons to scroll to the charge controller, and then press `Enter`.
The `XW MPPT80 xx: Setup` menu appears, where `xx` is the device number.

Viewing Basic and Advanced Settings

The charge controller has basic and advanced configuration menus. The basic menu contains items you might have to view and adjust on a routine basis. The advanced menu contains items intended for service personnel and one-time setup, such as auxiliary output and custom battery configuration.

To display the `Advanced Settings` menu item instead of the `Basic Settings` menu item, perform the following special keypress:

- ◆ From the `Setup` menu, press the `Enter`, up arrow, and down arrow buttons simultaneously.



On the `Setup` menu, `Basic Settings` disappears from the bottom of the list, and `Advanced Settings` appears at the top of the list.

After configuring the charge controller, help prevent unintended advanced configuration by using the combined keypress again to hide the advanced menu items.

Modifying Configurable Settings

Configurable settings are identified by square brackets [] around the values along the right side of the screen.

To select and change a configurable setting:

1. On the menu, press the up arrow or down arrow button to highlight the setting you want to change.
2. Press Enter to highlight the current value of the setting.
3. Press the up arrow or the down arrow button to change the value. Hold down the button to scroll through a large range of values quickly.
The previously set value appears with an asterisk (*) beside it.
4. Press Enter to select the value.

Configuring Battery Characteristics and Battery Charging

▲ WARNING

HAZARD OF FIRE AND EXPLOSION

Battery charging settings must be configured by qualified personnel in accordance with the battery manufacturer's recommended charging instructions.

Failure to follow these instructions can result in death or serious injury.

CAUTION

BATTERY DAMAGE

The charge controller is incapable of determining battery type and cannot warn against or disallow incorrect settings. Carefully check the settings for bulk, absorption, float, and equalization charge against the battery specifications. Incorrect settings can damage the battery or shorten battery life.

Failure to follow these instructions can result in equipment damage.

From various menus in the SCP you can:

- Enable battery equalization.
- Configure your battery type, voltage, and amp-hour capacity.
- Configure a custom battery type by adjusting settings for each battery charge stage and fine-tuning temperature-compensated charging.
- Monitor battery temperature.

Table 2-1 describes the settings available for the charge controller's battery configuration.

Table 2-1 Battery configuration settings

SCP Device Menu Item	Setting	Values	Default	Description
Setup	Equalize	Disabled Enabled	Disabled	Enables or disables battery equalization. If the battery type is set to GEL or AGM, this setting is not displayed.
Advanced Settings > Multi Unit Config > Connections	DC Conn	BattBank1...Batt Bankx	BattBank1	Sets the battery bank connected to the charge controller. This is important for networked installations where multiple devices must coordinate their activity around common DC connections.
Advanced Settings > Charger Settings	Batt Voltage	24V 48V	48V	Sets your nominal battery voltage. Select the nominal voltage level that matches your system's battery voltage. Changing the battery voltage will reset <code>Trigger Level</code> and <code>Clear Level</code> to their default values for the auxiliary output if <code>Trig Src</code> is set to <code>LowBattV</code> or <code>HighBattV</code> (see Table 2-4 on page 2-9).
Advanced Settings > Charger Settings	Batt Type	Flooded GEL AGM Custom	Flooded	Sets your battery type. Selecting <code>Custom</code> allows you to adjust equalize, bulk, absorption, and float voltage settings. You can also adjust battery temperature compensation from the <code>Custom Battery</code> menu. The <code>Custom</code> option is available only when advanced menus are displayed.

Table 2-1 Battery configuration settings

SCP Device Menu Item	Setting	Values	Default	Description
Advanced Settings > Charger Settings	Batt Capacity	0–10000Ah	440Ah	Sets the amp-hour capacity of your battery bank. Setting <code>Batt Capacity</code> to 0 disables the exit current threshold mechanism used to transition from absorption to float. As a result, the charge controller will transition to float once the <code>Max Absorption</code> timer has elapsed.
Advanced Settings > Charger Settings	Max Chg Rate	1–100%	100%	Sets the charging current limit.
Advanced Settings > Charger Settings	ReCharge Volts	24V: 20.0–27.0V 48V: 40.0–54.0V	25.0V 50.0V	Sets the voltage at which the charger transitions from float or no float back to bulk or from absorption back to bulk.
Advanced Settings > Charger Settings	Absorb Time	1–480min	180min	Sets the maximum time spent in the absorption stage.
Setup	Force Chg	Bulk Float No Float	Bulk	Manually advances the charge stage to bulk, float, or no float.
Advanced Settings > Charger Settings	Default Batt Temp	Cold Warm Hot	Warm	Sets the default battery temperature for compensation when a BTS is not connected. <code>Cold</code> is suitable for temperatures around 10 °C (50 °F), <code>Warm</code> for 25 °C (77 °F), and <code>Hot</code> for 40 °C (104 °F). This screen appears only when a BTS is not connected.
Setup > Meters	Batt Temp	-40–65 C	n/a	Shows the battery temperature (in Celsius) detected by the BTS. This screen appears only when a BTS is connected.
Advanced Settings > Charger Settings	Charge Cycle	3Stage 2StgNoFloat	3Stage	Sets the charging cycle: three-stage (bulk, absorption, float) or two-stage (bulk, absorption, no float).

Setting a Custom Battery Type

The `Custom Settings` menu item allows you to adjust charging and equalization voltage for batteries whose specifications fall outside of the default settings for the battery types that the charge controller offers.

You can also adjust the temperature compensation constant for the BTS from the `Custom Settings` menu item.

NOTICE

- Setting the battery type to `Custom` is possible only when the `Advanced Settings` menu item is displayed.
- The `Custom Battery` menu is displayed only when the battery type is set to `Custom`.
- All settings for configuring a custom battery type are based on the default settings for a flooded battery type.

The following table describes the available custom battery settings. To access the menu, go to `Advanced Settings > Charger Settings > Custom Settings`.

Table 2-2 Custom battery settings

Setting	Values	Default	Description
Eq1z Support	Enabled, Disabled	Enabled	Enables or disables equalization for the custom battery.
Eq1z Voltage	24V: 27.0–32.0V 48V: 54.0–64.0V	32.0V 64.0V	Sets the equalization voltage (consult your battery manufacturer for equalization voltage setting). This screen is hidden if <code>Eq1z Support</code> is disabled.
Bulk Voltage	24V: 20.0–32.0V 48V: 40.0–64.0V	28.8V 57.6V	Sets the bulk voltage for a custom battery.
Absorb Voltage	24V: 20.0–32.0V 48V: 40.0–64.0V	28.8V 57.6V	Sets the absorption voltage for a custom battery.
Float Voltage	24V: 20.0–32.0V 48V: 40.0–64.0V	27.0V 54.0V	Sets the float voltage for a custom battery.
BattTempComp	24V: -90–0mV/degC 48V: -180–0mV/degC	-54mV -108mV/C	Sets the battery temperature compensation for a custom battery. This setting is the reference that the BTS uses to adjust the charging voltage when the temperature falls above or below 25 °C. See “Battery Temperature Compensation” on page 2–7.

See “Default Battery Charging Settings” on page A–5 for default settings for standard battery types.

Battery Temperature Compensation

When battery charging voltages are compensated based on temperature, the charge voltage will vary depending on the temperature around the batteries. Temperature compensation can be accomplished automatically by using a BTS. The BTS attaches directly to the side of one of the batteries in the bank and provides precise battery temperature information. See “Installing the Battery Temperature Sensor” in the Xantrex XW MPPT 80 600 Solar Charge Controller Installation Guide for detailed instructions on how and where to install the BTS.

If a BTS is installed, the charge controlling process is automatically adjusted for the battery temperature. The charge controller uses the following coefficients to adjust the charging voltage¹:

- **Flooded Lead-Acid and Gel-Type Batteries (48 V nominal):**
-108 mV per degree Celsius
- **Absorbed Glass Mat (AGM)-Type Batteries (48 V nominal):**
-84 mV per degree Celsius

If using a BTS, when the battery temperature drops below 25 °C (77 °F), the regulation voltage setting automatically increases. When the temperature rises above 25 °C (77 °F) the regulation battery voltage setting automatically decreases. The temperature range where compensation is applied is between 0 °C and 50 °C. Outside of this temperature range, the compensation value is clamped at the corresponding value for either 0 °C or 50 °C.

If a BTS is not installed, configure the charge controller to use one of three temperature compensated charge settings:

- Cold: 10 °C (50 °F)
- Warm: 25 °C (77 °F)
- Hot: 40 °C (104 °F)

If significant seasonal variations are common in your area, change the settings multiple times during the year for optimal battery charging.

Configuring Peak Power Tracking

You can disable automatic maximum power point tracking and configure the reference voltage level from which the charge controller operates. Configuring the reference voltage is not required for normal operation, but it can be useful for testing purposes.

¹.For 24 V battery systems, divide these coefficients by two.

Table 2-3 Peak power tracking settings

SCP Device Menu Item	Setting	Values	Default	Description
Advanced Settings > Input Settings	MPPT AutoTrack	Disabled Enabled	Enabled	Enables or disables MPPT.
Advanced Settings > Input Settings	MPPT Ref Volts	195–600V	N/A	When tracking is set to Disabled , you can select the reference voltage from which the charge controller operates. When tracking is set to Enabled , the reference voltage updates to reflect tracking activity.
Advanced Settings > Multi Unit Config > Connections	PV In	SolarArray 1–16	SolarArray1	Sets the input connection for the charge controller.

Configuring the Auxiliary Output

Use the **Aux Settings** menu item to enable and configure the auxiliary output. You can use the auxiliary output to operate a relay, indicator light, vent fan, alarm, or any other required function. See “Auxiliary Output Functions” on page 1–9. For configurable trigger sources, you can define trigger level, trigger delay, clear level, and clear delay settings. Non-configurable trigger sources include errors, warnings, and faults.

To display the `Aux` menu auxiliary settings, select `Advanced Settings > Aux Settings`.

Table 2-4 Aux menu settings

Setting	Values	Default	Description
Manual Aux	ManualOff ManualOn Automatic	ManualOff	Sets the operating mode for the auxiliary output. When set to <code>Automatic</code> , the auxiliary output will operate according to the selected trigger source. You can toggle the auxiliary relay between NC and NO at any time by selecting <code>ManualOn</code> or <code>ManualOff</code> .
Note: The remaining settings in this table are only visible when <code>Manual Aux</code> is set to <code>Automatic</code> .			
Trig Src	<p>Configurable: LowBattV HighBattV LowArrayV HighArrayV LowBattTemp HighBattTemp HighHsTemp</p> <p>Not configurable: Fault GroundFlt1 GroundFlt2 InputOVFlt InputOVErr InputOVWrn OutputOVErr OutputOVWrn OutputOCErr BattOTErr BattOTWrn BattUTWrn HsOTErr HsOTWrn AmbOTErr AmbOTWrn CapOTErr FanErr FanFlt OutputUVErr OutputUVWrn InputOCErr OutputOCFlt NetPSFlt</p>	LowBattV	<p>Sets the desired condition to activate the auxiliary output. Changing <code>Trig Src</code> while the auxiliary output is already in the triggered state resets the auxiliary output.</p> <p>If <code>Trig Src</code> is set to <code>LowBattV</code> or <code>HighBattV</code>, then changing battery voltage (see Table 2-1 on page 2-4) will reset <code>Trigger Level</code> and <code>Clear Level</code> to their default values.</p> <p>For a description of the non-configurable faults, errors, and warnings that you can set for <code>Trig Src</code>, see Table 3-4, “Fault messages” on page 3-6, Table 3-5, “Error messages” on page 3-7, and Table 3-6, “Warning messages” on page 3-9.</p>

Table 2-4 Aux menu settings

Setting	Values	Default	Description
Trigger Level	Depends on Trigger Source (see Table 2-5)		<p>Sets the battery or array voltage to activate the auxiliary output. If the selected trigger source is HighBattTemp, LowBattTemp, or HighHsTemp, this screen displays Trigger Temperature Level in degrees Celsius. Changing Trigger Level while the auxiliary output is already in the triggered state resets the auxiliary output.</p> <p>This setting is hidden if the trigger source is set to an error, warning, or fault.</p>
Trigger Delay	0–600s	1s	<p>Sets how long—in seconds—the selected trigger source must be active before the auxiliary output activates. This can avoid unnecessary triggering by momentary loads.</p> <p>This setting is hidden if the trigger source is set to an error, warning, or fault.</p>
Clear Level	Depends on Trigger Source (see Table 2-5)		<p>Sets the battery or array voltage to turn off the auxiliary output. If the selected trigger source is HighBattTemp, LowBattTemp, or HighHsTemp, this screen displays Clear Temperature Level in degrees Celsius.</p> <p>This setting is hidden if the trigger source is set to an error, warning, or fault.</p>
Clear Delay	0–600s	1s	<p>Sets how long—in seconds—the trigger condition must remain inactive before the auxiliary output turns off.</p> <p>This setting is hidden if the trigger source is set to an error, warning, or fault.</p>

NOTICE

If the selected trigger source is LowBattV or HighBattV, changing the Batt Voltage setting will reset the Trigger Level and Clear Level settings to their default values

Trigger Source Descriptions

Configurable trigger sources are described below. The text in parentheses indicates how the trigger source appears on the SCP. The remaining trigger sources are errors, warnings, and faults that are not configurable. See their descriptions in Table 3-6, “Warning messages” on page 3–9.

Low battery voltage (LowBattV) Activates the auxiliary output when the battery voltage falls below the trigger setting for the trigger delay time. Deactivates the auxiliary output when the battery voltage rises above the clear setting for the clear delay time. Use this setting if you want the auxiliary output to control a relay to disconnect loads from a battery that is nearly discharged, or to activate a low-battery-voltage alarm such as a buzzer or light.

High battery voltage (HighBattV) Activates the auxiliary output when the battery voltage rises above the trigger setting for the trigger delay time. Deactivates the auxiliary output when the battery voltage falls below the clear setting for the clear delay time. This setting is useful for:

- Installations that have another external charging source such as a wind generator or hydro generator connected directly to the batteries. The charge controller’s auxiliary output can control a relay to disconnect the external charging source from the battery when the battery is close to being overcharged or control a relay to turn on a diversion load.
- Activating a high-battery-voltage alarm such as a buzzer or light.
- Activating a vent fan to disperse hydrogen from the battery compartment when the batteries reach their gassing voltage.

Low array voltage (LowArrayV) Activates the auxiliary output when the PV array voltage falls below the trigger setting for the trigger delay time. Deactivates the auxiliary output when the PV array voltage rises above the clear setting for the clear delay time.

High array voltage (HighArrayV) Activates the auxiliary output when the PV array voltage rises above the trigger setting for the trigger delay time. Deactivates the auxiliary output when the PV array voltage falls below the clear setting for the clear delay time. Use this setting if you want the auxiliary output to control a series latching relay to disconnect the PV array from the charge controller or trigger an alarm when the PV array voltage exceeds the trigger setting (the charge controller’s maximum operating voltage is 550 VDC).

Low battery temperature (LowBattTemp) Activates the auxiliary output when the battery temperature falls below the trigger setting for the trigger delay time. Deactivates the auxiliary output when the battery temperature rises above the clear setting for the clear delay time. Battery temperature is measured with a BTS. Do not use this setting if a BTS is not installed. With this setting, the auxiliary output can turn on an indicator alarm if the batteries are too cold. A battery with frozen electrolyte will not accept a charge.

High battery temperature (HighBattTemp) Activates the auxiliary output when the battery temperature rises above the trigger setting for the trigger delay time. Deactivates the auxiliary output when the battery temperature falls below the clear setting for the clear delay time. Battery temperature is measured with a BTS. Do not use this setting if a BTS is not installed. With this setting, the auxiliary output can turn on a fan to cool the battery compartment.

High heat sink temperature (HighHsTemp) Activates the auxiliary output when the charge controller's heat sink temperature rises above the trigger setting for the trigger delay time. Deactivates the auxiliary output when the heat sink temperature falls below the clear setting for the clear delay time. This setting can be used to trigger an alarm.

Fault (Fault) Activates the auxiliary output when any error, warning, or fault occurs. This trigger source is not configurable.

Trigger Source Configurable Ranges

This table contains the available configuration ranges and default settings for configurable trigger sources. The units vary according to the trigger source selected. If the selected trigger source is based on a battery voltage, the range also varies according to the nominal battery voltage of your system.

NOTICE	
Changing the trigger level resets the auxiliary output. If an auxiliary output trigger is active, changing the trigger level will clear the trigger.	

Table 2-5 Trigger source configuration ranges

Trigger Source	Range	Default Trigger	Default Clear
Low battery voltage (LowBattV)	24V: 18–26V	22V	24V
	48V: 36–52V	44V	48V
High battery voltage (HighBattV)	24V: 24–32V	28V	26V
	48V: 48–64V	56V	52V
Low array voltage (LowArrayV)	10–600V	190V	195V
High array voltage (HighArrayV)	190–600V	575V	500V
Low battery temperature (LowBattTemp)	-20.0–10.0°C	-10.0°C	-5.0°C
High battery temperature (HighBattTemp)	30.0–60.0°C	45.0°C	40.0°C
High heat sink temperature (HighHsTemp)	-20–95°C	90°C	85°C

Configuring Device Settings

From various menus, you can change the operating mode of the charge controller and view the charge controller's device number. These activities might be necessary when performing service or diagnostics as well as when adding another Xanbus-enabled device to the system.

Table 2-6 Device settings

SCP Menu Item	Setting	Values	Default	Description
Setup	Mode	Operating Standby	Operating	Operating is the normal mode for the charge controller. Standby disables the charge controller so that it cannot charge. The charge controller still draws some power from the battery to operate.
Advanced Settings > Multi Unit Config	Dev Number	00 to 31	00	Displays the device number for the charge controller. This number is set when the charge controller is commissioned and uniquely identifies devices of the same type (charge controllers, inverterchargers, control panels, and so on) in a networked installation.
Select Device > System Settings > View Device Info	F/W Rev. 1.00.00 BN 5	N/A	N/A	Firmware version and firmware build number.

⚠ WARNING
<p>HAZARD OF FIRE AND EXPLOSION</p> <p>Do not use the <code>Copy from</code> command to copy settings unless the battery banks are identical – same size, type, and so on.</p> <p>Failure to follow these instructions can result in death or serious injury.</p>

SCP Menu Item	Setting	Values	Default	Description
Advanced Settings	Copy from	All available device numbers.	01	<p>Enables one-step configuration of a new charge controller in a multi-unit installation. Select the device number of the charge controller from which you want to copy the setup. This screen is hidden when no compatible devices are found.</p> <p>The <code>Copy from</code> command copies all charger settings and custom battery settings from the selected charge controller.</p>

NOTICE

The Copy from command will not give you any indication that it has completed its task. To check that the charger settings have been copied properly, view some of the settings you originally configured.

Settings that are copied from one charge controller to another are:

- Batt Type
- Batt Capacity
- Max Chg Rate
- Charge Cycle
- ReCharge Volts
- Absorb Time
- Default Batt Temp
- Batt Voltage
- DC Conn
- Custom battery settings (if Custom battery type selected) including Eqlz Support, Eqlz Voltage, Bulk Voltage, Absorb Voltage, Float Voltage, and BattTempComp.

Reducing Tare Loss

By default, the charge controller is configured to reduce tare losses at night by shutting off the auxiliary power supply. To further reduce power consumption at night, you can configure the charge controller to also shut off the network (Xanbus) power supply. You can change these settings using the **Adv Features** menu item provided you are using an SCP with firmware version 1.03 or higher.

To display the tare loss settings, select **Advanced Settings > Adv Features**.

Table 2-7 Tare loss settings^a

Setting	Values	Default	Description
NetPS Night Dis	Enabled Disabled	Disabled	Enables or disables the network power supply (Xanbus) nighttime disconnect. If your system does not require Xanbus communication during the night, then set it to Enabled to reduce power consumption. The power supply will automatically turn off two hours after sunset, and then turn on again at sunrise. If your system requires Xanbus communication during the night, then leave it set to Disabled .
Lo Pwr at Night	Enabled Disabled	Enabled	Enables or disables the auxiliary power supply nighttime disconnect. Leaving the setting as Enabled reduces tare losses during the night. See “Electrical Specifications” on page A-2 for exact specifications.

a.SCP with firmware version 1.03 or newer only.

Resetting to Factory Defaults

From the **Advanced Settings** menu item, you can restore factory default settings.

Table 2-8 Resetting to factory defaults setting

Setting	Values	Default	Description
Restore Defaults	N/A	N/A	Returns configurable settings to factory defaults. You will be prompted with a warning asking you to confirm that you want to restore defaults. Press Enter to continue.

The following are reset:

- Configurable battery/charger settings
- Configurable auxiliary output settings
- Configurable input settings

3

Operation

Chapter 3 contains information about operating the charge controller.

For Information on:	See:
"Viewing Status Information on the Charge Controller"	page 3-3
"Viewing Status on the SCP"	page 3-3
"Viewing Active Faults, Errors, and Warnings"	page 3-4
"Viewing Fault, Error, and Warning Logs"	page 3-11
"Viewing Harvest Logs"	page 3-11
"Equalizing Batteries"	page 3-12

Viewing Status Information on the Charge Controller

The charge controller has three LEDs for displaying basic operating information. They are On/Charging (green), Error/Warning (red), and Equalize (orange).

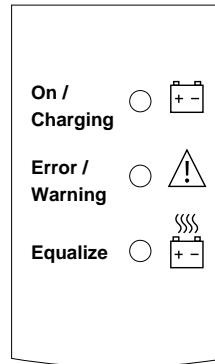

Figure 3-1 Charge controller status LEDs

Table 3-1 Charge controller status LEDs

LED	Description
On/ Charging (Green)	<ul style="list-style-type: none"> • Solid when the charge controller is connected to a battery, providing visual feedback that the charge controller is powered on. • Flashing at a variable rate when the charge controller is charging a battery. Slow flashing indicates a low charge rate, and fast flashing indicates a faster charge rate.
Error/ Warning (Red)	<ul style="list-style-type: none"> • Solid when the charge controller has detected an error or fault condition. • Flashing at a constant rate when the charge controller has detected a warning condition. <p>View the error, fault, or warning and its description on the SCP.</p>
Equalize (Orange)	<ul style="list-style-type: none"> • Solid when an equalize charge has been enabled via the SCP but has not yet started (the charge controller must complete a full bulk and absorption cycle before it can begin the equalize cycle). • Flashing at a constant rate when the charge controller is performing the equalize charge to the batteries. After the equalize charge has completed, the LED goes dark.

Viewing Status on the SCP

Use the SCP to configure and view system information and operating status. See Appendix B, “Xantrex XW System Control Panel Menus” for an overview of the SCP, or download the entire SCP Owner’s Guide (Document Part Number 975-0298-01-01) at www.schneider-electric.com. The charge controller also has three LEDs for displaying basic status regarding charging, equalization, and fault, error, and warning conditions.

- When in Charge Control mode the SCP displays parameters such as PV voltage, battery voltage, and charge current on the XW MPPT80 Home screen.
- When a fault or error condition exists, the SCP Fault/Warning light is solid, and the SCP shows `Fault Active` on the XW MPPT80 Home screen.
- When a warning condition exists, the SCP Fault/Warning light is flashing, and the SCP shows `Warning Active` on the XW MPPT80 Home screen.

Normal Operation

From the XW MPPT80 `Setup` screen, select `Meters` to view normal operation information. This information is refreshed once per second.

Table 3-2 Normal operation information (Meters screen)

Display	Description
PV In Power	Measured input power.
PV In	Measured input voltage and current.
DC Out Power	Power being produced by the charge controller now.
DC Out	Measured output voltage and output current.
Time in Float 00:00:00	Elapsed time that the charge controller has been in float in hh:mm:ss format.
Today	Accumulated amp hours and kilowatt hours produced today by the charge controller.
Life	Lifetime accumulated amp hours and kilowatt hours produced by the charge controller.
Batt Temp	Battery temperature detected by the BTS. If a BTS is not connected, then no value is shown.
State	Charge stage. See Table 3-3 on page 3-4.
Aux	Auxiliary output state. See Table 2-4 on page 2-9.
Thermal Derating	Indicates whether the charge controller is derating output power due to high operating temperatures. See Figure A-4 on page A-6.

Charge Stages

The charge stages displayed on the SCP are described in Table 3-3. The charge states are displayed under `State` on the `Meters` screen.

Table 3-3 Charge stages

Text	Description
Bulk	Batteries are charging at the maximum current available from the charge controller. If the charge controller shuts down because of low input PV voltage, then charging will resume in bulk mode. This means the charge controller starts in bulk at the beginning of every day, regardless of the battery voltage. If the batteries are fully charged, the bulk/absorption cycle finishes after a short period and the charge controller transitions to float/no float (depending on charge cycle configuration).
Absorb	After transitioning from bulk mode, the charge controller holds the battery voltage at the absorption voltage setting and the charge current gradually declines as the battery capacity is restored. The charge controller stops absorption charging when one of two conditions are met, as described in “Absorption Stage” on page 1–4.
Float	Battery voltage is held at the float voltage setting. When the battery voltage drops below the <code>ReCharge Volts</code> setting for a cumulative period of one minute, a new bulk charge cycle is triggered.
No Float	The charge controller does not output any power during this stage. When the battery voltage drops below the <code>ReCharge Volts</code> setting for a cumulative period of one minute, a new bulk cycle is triggered.
Equalize	A deliberate overcharge designed to return each battery cell to optimum condition by reducing sulfation and stratification in the battery. An equalization charge lasts one hour.
Not Charging	No charging is occurring because the input power from the PV array has fallen below the minimum PV array operating voltage (as specified in “Electrical Specifications” on page A–2).

Viewing Active Faults, Errors, and Warnings

When a fault, error, or warning occurs, a message is displayed on the SCP. You can also view active faults, errors, and warnings from the `System Settings` menu.

Warning messages indicate a problem that could affect normal operation. The charge controller’s red LED flashes when there is a warning condition. The SCP Fault/Warning light flashes red, and the warning message is displayed on the SCP. Normal operation continues until the warning escalates to a fault or error condition.

Fault messages indicate a fault or error condition. The charge controller’s red LED is solid when there is a fault or error condition. The SCP Fault/Warning light is solid red, and the fault message is displayed on the SCP. When a fault or error occurs, MPPT and charging functions could be disabled.

The following faults do not disable normal operation:

- Fan over voltage
- Fan over current
- Fan under voltage
- Fan under current
- Network power supply

Most warnings, errors, and faults clear automatically once the condition that caused them goes away. However, the following faults must be cleared manually:

- Auxiliary power supply
- Ground fault protection
- Input over voltage
- Output over current
- Fan over voltage
- Fan over current
- Fan under voltage
- Fan under current
- Network power supply

To view the complete list of active faults, errors, and warnings:

1. On the `Select Device` menu, scroll to `System Settings`, and then press Enter.
The `System Settings` menu opens.
2. Scroll to `View Fault List` or `View Warning List`, and then press Enter.
The fault/error or warning menu opens.
3. Press the down button to view additional fault, error, or warning messages. If there are no active faults, errors, or warnings, no messages are displayed.

To manually clear a fault, error, or warning:

1. On the `Select Device` menu, scroll to `System Settings`, and then press Enter.
The `System Settings` menu opens.
2. Scroll to `Clear All Flts/Wrns`, and then press Enter.¹

¹.Additional steps are required for a ground fault. See "GroundFlt1" in Table 3-4.

Faults

Table 3-4 lists all possible faults. Faults are conditions that indicate that the charge controller might have incurred permanent damage or that user intervention is required before the charge controller will operate again. If one of these faults occur, the charge controller might also need to be serviced before it can be fully operational again.

Table 3-4 Fault messages

Display Text (Description)	Fault ID	Definition
AuxPSF1t (Auxiliary power supply fault)	F54	More than two auxiliary power supply errors (F26) have occurred within one minute. Damage to the charge controller is possible, so the fault will not clear until an operator clears it manually using the SCP.
GroundF1t1 (Ground fault, type 1)	F56	A PV ground fault has been detected. The ground fault message clears after system power is removed, the ground fault is corrected, the GFP fuse is replaced by qualified personnel (negative or positive grounded systems only), and system power is restored. See the Xantrex XW MPPT 80 600 Solar Charge Controller Installation Guide for more information.
GroundF1t2 (Ground fault, type 2)	F83	A problem with the hardware circuitry used to detect ground faults exists. Contact customer service for assistance.
InputOVF1t (Input over voltage fault)	F74	Input voltage has exceeded 600 VDC. Damage to the charge controller is possible, so the fault will not clear until an operator clears it manually using the SCP.
FanOVF1t (Fan over voltage fault)	F75	Fan voltage has risen above 13.8 V. The fan will cease operating, but the charge controller will continue operating though it will probably experience power derating. The fault will not clear until an operator clears it manually using the SCP.
OutputOCF1t (Output over current fault)	F78	Three fast output (F71) or slow output (F73) over current errors have occurred within 30 seconds. The fault will not clear until an operator clears it manually using the SCP.
FanOCF1t (Fan over current fault)	F79	More than two Fan Errors have occurred within 30 seconds. The fan will cease operating, but the charge controller will continue operating though it will probably experience power derating. The fault will clear itself when the operator toggles power to the charge controller.

Table 3-4 Fault messages

Display Text (Description)	Fault ID	Definition
FanUVF1t (Fan under voltage fault)	F80	Fan voltage has fallen below 3.5 V. The fan will cease operating, but the charge controller will continue operating though it will probably experience power derating. The fault will not clear until an operator clears it manually using the SCP.
FanUCF1t (Fan under current fault)	F81	Fan current has fallen below 0.5 A for 100 milliseconds. The fan will cease operating, but the charge controller will continue operating though it will probably experience power derating. The fault will not clear until an operator clears it manually using the SCP.
NetPSF1t (Network power supply fault)	F82	<ul style="list-style-type: none"> • A short circuit or an overload condition has been detected on the Xanbus network power supply. • An over voltage event has been detected on the Xanbus network power supply. <p>The network power supply will be turned off, and loss of Xanbus communication is possible. The fault will not clear until an operator clears it manually. The operator might have to power cycle the charge controller if no other devices are present on the Xanbus network to provide network power to run the SCP.</p>

Errors

Table 3-5 lists all possible errors. Errors are situations where the charge controller has stopped itself from operating because of a problem.

Table 3-5 Error messages

Display Text (Description)	Error ID	Definition
CapOTErr (Capacitor over temperature error)	F2	Output capacitor temperature has risen above 100 °C (212 °F) for 5 seconds. The error clears itself when the capacitor temperature falls below 90 °C (194 °F) for 30 seconds. This error should not normally occur. If it is triggered multiple times, the charge controller must be serviced.
BattOTErr (Battery over temperature error)	F4	Battery temperature has risen above 60 °C (140 °F) for 30 seconds. The error clears itself when the battery temperature falls below 55 °C (131 °F) for 30 seconds.
AmbOTErr (Ambient over temperature error)	F5	Ambient temperature inside the charge controller has risen above 80 °C (176 °F) for 5 seconds. The error clears itself when the ambient temperature falls below 65 °C (149 °F) for 30 seconds.

Table 3-5 Error messages

Display Text (Description)	Error ID	Definition
InputOVerErr (Input over voltage error)	F9	Input voltage has exceeded the input over voltage shut off value, which is dependent upon temperature measured on the heatsink (Vin High Threshold in Figure 3-2 on page 3–10). The error clears itself when the input voltage falls below the input over voltage restart value (Vin Restart Threshold in Figure 3-2 on page 3–10).
OutputUVImmErr (Output under voltage immediate error)	F10	Output voltage has fallen below 15.8 VDC. The error clears itself when the voltage rises above 19.0 VDC for 1 second.
OutputUVErr (Output under voltage error)	F11	24 V System: Output voltage has fallen below 18.0 VDC. The error clears itself when the voltage rises above 19.0 VDC for 1 second. 48 V System: Output voltage has fallen below 36.0 VDC. The error clears itself when the voltage rises above 38.0 VDC for 1 second.
AuxPSErr Auxiliary power supply error	F26	Auxiliary power supply is not within its expected operating range. The error clears itself after 1 second and the auxiliary power supply will attempt to restart.
HsOTErr (Heat sink over temperature error)	F55	Heat sink temperature has risen above 90 °C (194 °F) for 5 seconds. The error clears itself when the heat sink temperature falls below 80 °C (176 °F) for 30 seconds.
SetupErr	F69	Multiple charge controllers connected to the Xanbus network have the same device number. The error will clear when the operator changes the device numbers of the duplicate charge controllers. The device number can be changed in the Multi Unit Config screen of the SCP.
OutputOVerErr (Output over voltage error)	F70	24 V System: Output voltage has risen above 33.0 VDC for 1 second. The error clears itself when the voltage falls below 32.0 VDC for 1 second. 48 V System: Output voltage has risen above 65.0 VDC for 1 second. The error clears itself when the voltage falls below 64.0 VDC for 1 second.
OutpFastOCErr (Fast output over current error)	F71	Output current has risen above 117.5 ADC. The error clears itself after 5 seconds. If the error is triggered three times in a span of 30 seconds, then it must be cleared manually.
OutpSlowOCErr (Slow output over current error)	F73	Output current has risen above 90.0 ADC for 10 milliseconds. The error clears itself after 5 seconds.

Table 3-5 Error messages

Display Text (Description)	Error ID	Definition
FanOCErr (Fan over current error)	F76	Fan current has risen above 1.6 A for 20 milliseconds. The error clears itself when fan current falls below 1.0 A for 1 second.
InputOCErr (Input over current error)	F77	PV current has risen above 25 ADC. The error clears itself after 5 seconds.

Warnings

Table 3-6 lists all possible warnings. Warnings indicate that one of the charge controller's operating parameters is approaching the specified limits for the device.

Table 3-6 Warning messages

Display Text (Description)	Warning ID	Definition
BattOTWrn (Battery over temperature warning)	W4	Battery temperature has risen above 50 °C (122 °F) for 10 seconds. The warning clears itself when the battery temperature falls below 45 °C (113 °F) for 10 seconds.
AmbOTWrn (Ambient over temperature warning)	W5	Ambient temperature inside the charge controller has risen above 70 °C (158 °F) for 10 seconds. The warning clears itself when the ambient temperature falls below 65 °C (149 °F) for 10 seconds.
BattUTWrn (Battery under temperature warning)	W9	Battery temperature has fallen below -20 °C (-4 °F) for 10 seconds. The warning clears itself when the battery temperature rises above -10 °C (14 °F) for 10 seconds.
Input over voltage warning (InputOVWrn)	W11	This warning follows the same curve as the Input over voltage error, but it triggers 10 V lower. The warning clears itself when the voltage falls to the input over voltage restart value – 15 V for 1 second. The input over voltage restart value is Vin Restart Threshold in Figure 3-2 on page 3–10.

Table 3-6 Warning messages

Display Text (Description)	Warning ID	Definition
OutputUVWrn (Output under voltage warning)	W12	<p>24 V System: Output voltage has fallen below 20.0 VDC for 10 seconds. The warning clears itself when the voltage rises above 21.0 VDC for 10 seconds.</p> <p>48 V System: Output voltage has fallen below 40.0 VDC for 10 seconds. The warning clears itself when the voltage rises above 42.0 VDC for 10 seconds.</p>
OutputOVWrn (Output over voltage warning)	W34	<p>24 V System: Output voltage has risen above 31.5 VDC for 10 seconds. The warning clears itself when the voltage falls below 30.5 VDC for 10 seconds.</p> <p>48 V System: Output voltage has risen above 63.0 VDC for 10 seconds. The warning clears itself when the voltage falls below 61.0 VDC for 10 seconds.</p>
HsOTWrn (Heat sink over temperature warning)	W35	Heat sink temperature has risen above 85 °C (185 °F) for 10 seconds. The warning clears itself when the heat sink temperature falls below 80 °C (176 °F) for 10 seconds.

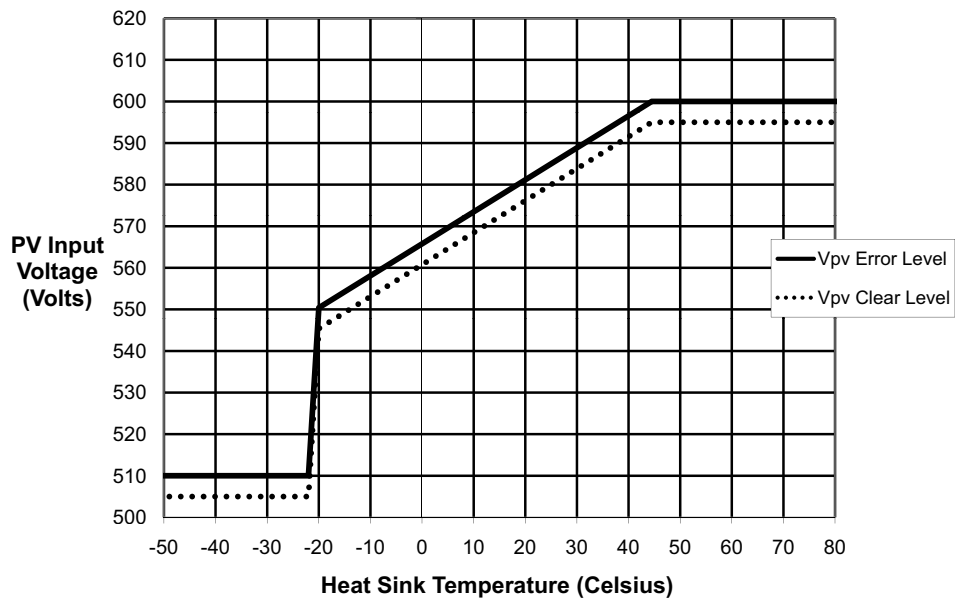

Figure 3-2 Over voltage protection

Viewing Fault, Error, and Warning Logs

The SCP displays fault, error, and warning logs stored on the charge controller.

Table 3-7 History menu items

SCP Device Menu	Item	Description
Setup > View Device Info	View Fault Log	Displays a log of the faults and errors.
Setup > View Device Info	View Warning Log	Displays a log of the warnings.

- To view the fault and error logs, go to Setup > View Device Info > View Fault Log.
- To view the warning logs, go to Setup > View Device Info > View Warning Log.

Press the down arrow to view all the entries in the log. The entries are listed chronologically, with the most recent fault, error, or warning at the top of the list. The fault, error, or warning number, date, and time are displayed. Press Enter to view details for a particular entry, including the name. The twenty most recent entries are stored.

Viewing Harvest Logs

The SCP displays the daily, monthly, and yearly performance logs stored on the charge controller.

NOTICE

To record monthly and yearly logs, the charge controller must be connected to a Xanbus network real-time clock source. If you want monthly and yearly logs to be created and stored, make sure the charge controller is attached to the Xanbus network with one of the following:

- Xantrex XW Hybrid Inverter/Charger
- SCP
- Gateway

Table 3-8 Harvest logs menu items

SCP Device Menu	Item	Description
Setup > Harvest Logs	Daily Logs	Displays a log of the charge controller's amp-hour and kilowatt-hour production for the day as well as the peak power output and time in float for the day.
Setup > Harvest Logs	Monthly Logs	Displays a log of the aggregate total for amp hours and kilowatt hours produced during the month as well as the peak power output and time in float for the month.
Setup > Harvest Logs	Yearly Logs	Displays a log of the aggregate total for amp hours and kilowatt hours produced during the year as well as the peak power output and time in float for the year.

Daily Logs

To view the daily logs, go to Setup > Harvest Logs. From the `Daily Logs` screen, press Enter. Press the down arrow button to scroll through the daily logs, starting with the current date. The charge controller stores up to 62 daily logs. After 62 days, the oldest daily log is overwritten.

Monthly Logs

To view the monthly logs, go to Setup > Harvest Logs. From the `Monthly Logs` screen, press Enter. Press the down arrow button to scroll through the monthly logs, starting with the current month. The charge controller stores up to 24 monthly logs. After 24 months, the oldest monthly log is overwritten.

Yearly Logs

To view the yearly logs, go to Setup > Harvest Logs. From the `Yearly Logs` screen, press Enter. Press the down arrow button to scroll through the yearly logs, starting with the current year. The charge controller stores up to 12 yearly logs. After 12 years, the oldest yearly log is overwritten.

Equalizing Batteries

Equalization charging is the process of deliberately charging a battery or battery bank at a high voltage for a set period of time. Equalize charging remixes the electrolyte, helps to remove sulfate buildup on the battery plates, and balances the charge of individual cells.

Make sure to read all cautions and warnings regarding equalization charging batteries before allowing an equalization charge to occur.

NOTICE

In a system where more than one device is capable of equalizing batteries (such as a system including multiple charge controllers and Xantrex XW Hybrid Inverter/Chargers), there is no system-wide equalization command for all devices. To equalize with multiple devices, each would have to be enabled individually. Alternatively, equalization can be performed using only one device. During the equalization process, one device applies the equalization charge while the other devices continue to operate in synchronized charge mode, typically in float (three-stage charging) or no float (two-stage charging).

⚠ WARNING**HAZARD OF EXPLOSION**

Equalization charging generates explosive gases which might escape from the battery. Make sure adequate ventilation is provided. Never leave a battery unattended during equalization. Follow the battery manufacturer's recommended actions for determining the appropriate point at which to stop the equalization process, for example, by monitoring electrolyte specific gravity.

Failure to follow these instructions can result in death or serious injury.

CAUTION**BATTERY DAMAGE**

Never equalize a battery more than necessary. Equalization can damage your batteries if performed too frequently or done improperly. Always check electrolyte level before and after equalization. Fill with distilled water according to the battery manufacturer's recommendation.

The charge controller enables equalization only when the battery type is set to Flooded. Equalize mode is disabled if you have selected GEL and AGM as the battery type. As a general rule, do not equalize a battery unless there are provisions to add water to it and the manufacturer recommends equalization.

Failure to follow these instructions can result in equipment damage.

CAUTION**DC LOAD EQUIPMENT DAMAGE**

Equalization voltage could be as high as 32 V (for 24 V systems) or 64 V (for 48 V systems) and might damage some types of DC load equipment connected to the battery. Disconnect any loads that are not rated to withstand the applicable equalization voltage.

Failure to follow these instructions can result in equipment damage.

NOTICE

The Xantrex XW Hybrid Inverter/Charger and PDP will not be damaged by equalization voltage and do not need to be disconnected during equalization.
--

Follow the battery manufacturer's recommendations for equalizing your batteries. As a guide, a heavily used flooded battery might need to be equalized once a month, while a battery in light service might only need to be equalized every two to four months.

The equalization process lasts one hour. When the equalization period has expired, the charge controller will return to either the float or no float charge stage.

To enable battery equalization:

1. On the **Setup** menu screen scroll to **Equalize**, and then press **Enter**.
2. Change the setting to **Enabled**.

The charge controller goes back to the bulk stage and goes through bulk and absorption before entering the equalization stage. The full charge cycle makes sure the batteries are fully charged before an equalization is attempted.

The charge controller applies the equalization charge for one hour. You can stop the equalization process manually at any time by changing the setting to **Disabled**.

The one hour equalization timer will continue to run even if there is insufficient power from the PV array to support this charge mode.

To determine when battery equalization is complete:

- ◆ Follow the battery manufacturer's recommendations for equalizing the batteries. These recommendations will include methods such as monitoring the specific gravity (SG) of the electrolyte using a battery hygrometer and stopping the equalization when the SG has stopped increasing.
 - If the recommended point is reached before the automatic one hour equalization timer runs out, then manually stop the equalization by changing the setting to **Disabled**.
 - If the recommended point is not reached after one hour, the charge controller will automatically exit the equalization stage. You can re-start equalization by following the process above and continue equalizing until the battery manufacturer's recommendation is met.

To manually stop battery equalization:

1. On the **Setup Menu**, scroll to **Equalize**, and then press **Enter**.
2. Change the setting to **Disabled**.

Equalization stops, and the charge controller goes to either the float or no float stage, depending on the charge mode selected.

4

Troubleshooting

Chapter 4 contains information about identifying and resolving possible problems that might arise while using a charge controller.

Troubleshooting

Table 4-1 lists possible problems that might arise when using the charge controller.

Table 4-1 Charge controller problems

Problem	Possible Cause	Solution
Battery voltage is exceeding bulk and float settings in cold weather and not reaching settings in hot weather.	The BTS is compensating charging voltages based on battery temperature.	No problem. This is the intended operation.
The charge controller's Error/Warning (red) LED is on or flashing.	An active fault, error, or warning is present on the charge controller.	See "Viewing Active Faults, Errors, and Warnings" on page 3-4 to determine which alarm is active on the charge controller. The tables in this section provide detailed information on why various alarms could be occurring on the charge controller.
Battery equalization was enabled but did not occur.	The charge controller must complete a bulk/absorption cycle before it can initiate an equalization cycle.	See "Equalizing Batteries" on page 3-12 for information on equalization charging. See "Viewing Status Information on the Charge Controller" on page 3-2 for information on determining the status of the equalization cycle.
BTS information does not show up on the charge controller's Meters screen on the SCP.	The BTS reading is only shown on the Meters screen if the BTS is physically connected to the device you are viewing on the SCP. All devices share BTS information, but they only report the information to the SCP if they have the BTS plugged into their BTS port.	Navigate to the Meters screen on the SCP for the device that has the BTS connected to it.

Table 4-1 Charge controller problems

Problem	Possible Cause	Solution
Thermal derating is indicated on the SCP.	<p>A. The charge controller is operating in a high ambient temperature environment at high power levels.</p> <p>B. The fans are not working properly.</p>	<p>A. The charge controller is specified to operate at full output power up to 45 °C. Derating occurs at temperatures above this level.</p> <p>B. Make sure that you have not blocked the ventilation holes at the top and bottom of the charge controller and that you have provided sufficient clearance for proper ventilation of the charge controller. Check the active fault list and the historical fault log on the SCP to see if the charge controller has registered any faults or errors related to fan operation.</p>
The charge controller's Error/Warning (red) LED is on, and the SCP indicates an input over voltage error (F9) for the charge controller.	The PV panels are producing voltage levels that are outside the operating specifications for the charge controller. This is likely due to the panels experiencing extreme cold temperatures for the region.	This condition will correct itself when the panels warm up and the voltage decreases to within operating specifications. If it occurs regularly, then the installation likely has too many PV panels in series and might need reconfiguration to lower the voltage to the charge controller. See "Electrical Specifications" on page A-2 for details on the charge controller's operating range.
The charge controller's On/Charging (green) LED is flashing.	The charge controller is outputting charge current.	No problem. This is intended operation. See "Viewing Status Information on the Charge Controller" on page 3-2 for LED status information.
The SCP turns off completely after sunset.	The SCP is powered by the output of the charge controller, and it has been configured to turn off the Xanbus power supply during the night.	See "Reducing Tare Loss" on page 2-16 for more information on disabling certain power supplies at night to reduce night time tare losses.
The charge controller's Error/Warning (red) LED is on, and the SCP is blank.	The network power supply fault ("F82" on page 3-7) has been triggered and has disrupted power to the SCP.	Remove power to the charge controller by opening the PV and battery disconnects long enough for the red and green LEDs to turn off. Restore power by closing the PV and battery disconnects, and then confirm that the SCP resumes operation. Contact customer service if the problem is not resolved.

A

Specifications

Appendix A provides the specifications for the charge controller.

For information on:	See:
"Electrical Specifications"	page A-2
"Default Battery Charging Settings"	page A-5
"Mechanical Specifications"	page A-5
"Output Power Versus Ambient Temperature"	page A-6
"Accessories"	page A-6
"Regulatory Approvals"	page A-7

All specifications are subject to change without notice.

Electrical Specifications

Maximum PV Array Open Circuit Voltage	600 VDC
PV Array Voltage Operating Range	195 to 550 VDC
PV Array Voltage Full Power Range ^a	230 to 550 VDC
Maximum Power Point Tracking Range	195 to 510 VDC
PV Input Start Voltage	230 VDC
Maximum Operating Current	23 A
Maximum Array Short Circuit Current at STC	28 A
Absolute Maximum Array Short Circuit Current Under Any Conditions	35 A (See the Notice on the next page for more information)
Nominal Battery Voltages	24 and 48 VDC (Default is 48 V)
Battery Voltage Operating Range	16 to 67 VDC
Maximum Charging Current	80 A
Maximum Charging Power	2560 W (nominal 24 V battery bank) 4800 W (nominal 48 V battery bank)
Maximum Power Conversion Efficiency	94% (nominal 24 V battery bank) 96% (nominal 48 V battery bank)
Auxiliary Output	Dry contact switching up to 60 VDC, 30 VAC, 8 A
Charger Regulation Method	Three stage (bulk, absorption, float) Two stage (bulk, absorption) Manual equalization
Tare Losses ^b	less than 1.0 W (Xanbus power supply on) less than 0.5 W (Xanbus power supply off)

a. Full power output below 230 V is not assured. See "Operating Below the PV Array Voltage Full Power Range" on page A-3 for more information.

b. These values are based on the following specifications:

- The battery voltage is 48 V.
- The auxiliary power supply is shut off at night. See "Reducing Tare Loss" on page 2-16 for more information.

NOTICE

- PV array voltages often exceed STC voltage specifications, especially when the array is cold. A voltage temperature correction factor based on the local code (i.e., NEC 690 or CEC Section 50), ambient temperature conditions, and module manufacturer specifications must be applied to the array STC V_{OC} to keep array voltage within specifications listed above.
- PV array current might exceed STC current specifications, especially under intense sunlight, certain atmospheric conditions, or from reflections (i.e., water, snow, or ice). Local codes typically apply a multiplier to the PV array I_{SC} to determine “maximum current” for design purposes. The “Maximum PV Current” specification above includes the 125% multiplier required by the NEC and the CEC. Accordingly, the PV array STC I_{SC} cannot exceed 28 A.

MPPT Voltage Range

The charge controller’s Maximum Power Point Tracking (MPPT) algorithm maximizes the output energy of PV arrays as long as the operating voltage is within the MPPT operational window. Make sure that the PV arrays used in the system operate within the MPPT operational window. The MPPT operational window are shown below.

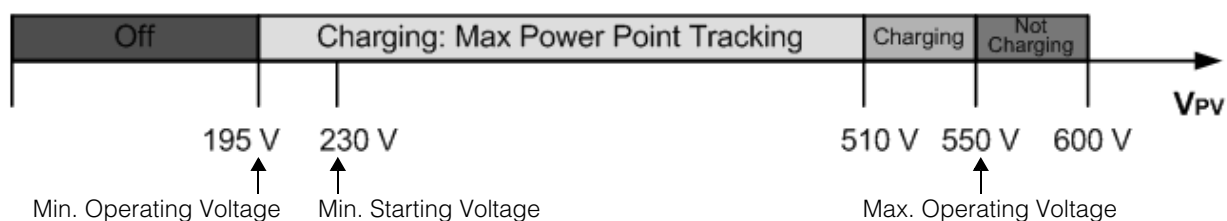

Note:

Max V_{OC} 600 V

Input current limit 35 A (array I_{SC} including 125% code multiplier)

Output current limit 80 A

Figure A-1 MPPT operational window

Operating Below the PV Array Voltage Full Power Range

When the charge controller is operating on a 48 V battery bank and a PV array where the MPP is below 230 V, full output power is not assured. Figure A-2 and Figure A-3 show the maximum output current and maximum output power that can be produced when the charge controller is operating below 230 V. The actual amount of current and power that your charge controller can produce below 230 V will depend on the actual battery voltage and the amount of solar power available from your panels. Full output current is available on 24 V battery systems across the entire input voltage operating range.

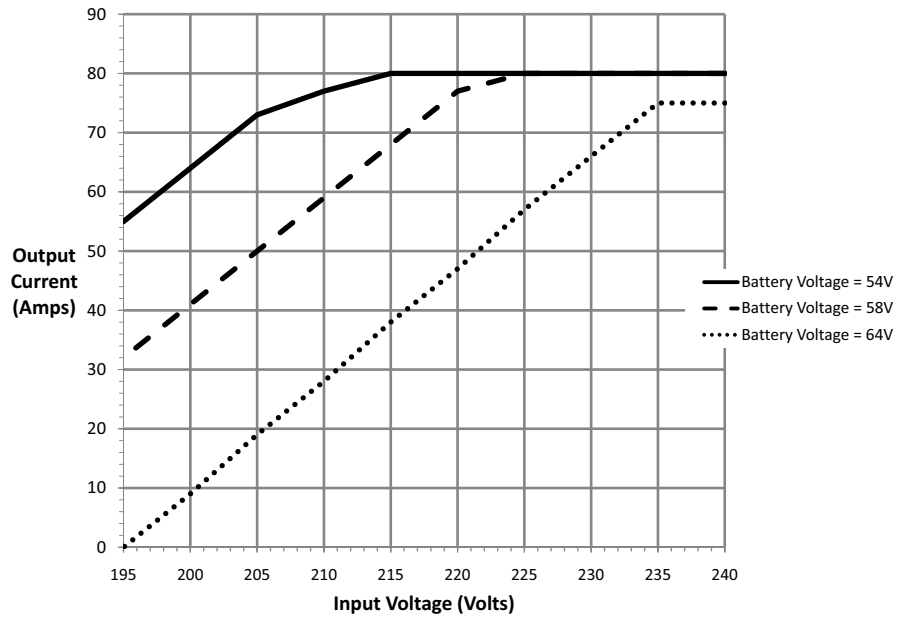

Figure A-2 Maximum expected output current versus input voltage

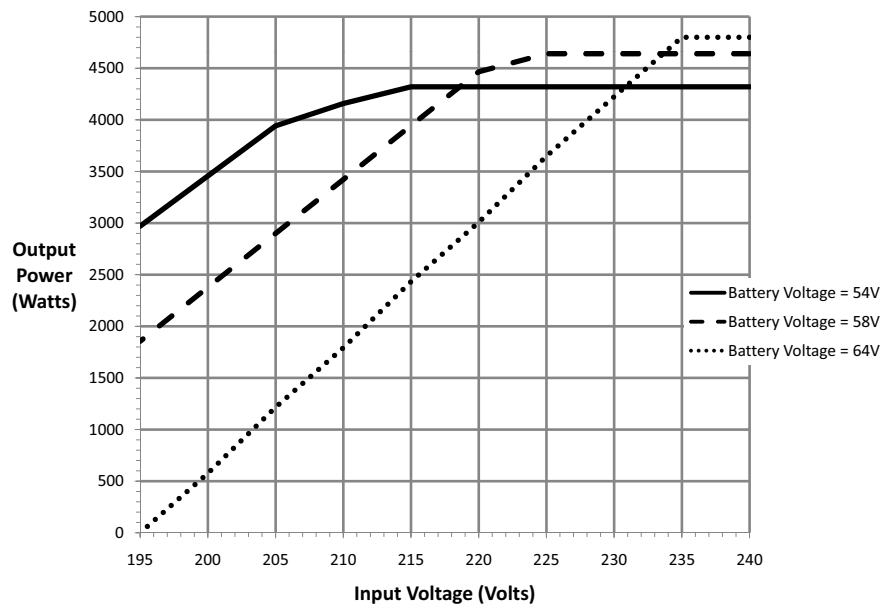

Figure A-3 Maximum expected output power versus input voltage

Default Battery Charging Settings

All settings in the following table are based on a 48 V nominal battery bank. For a 24 V nominal battery bank, divide the voltage values in this table by two.

Setting	Battery Type		
	Flooded ^a	Gel	AGM
Equalize Voltage	64.0 V	n/a	n/a
ReCharge Voltage	50.0 V	50.0 V	50.0 V
Bulk Voltage	57.6 V	56.8 V	57.2 V
Absorption Voltage	57.6 V	56.8 V	57.2 V
Float Voltage	54.0 V	55.2 V	53.6 V
Absorption Time	360 min	360 min	360 min
Batt Temp Comp	-108 mV/C	-108 mV/C	-84 mV/C

a. When Custom is selected for the battery type, the default settings are based on the flooded battery type.

Mechanical Specifications

Enclosure Type	IP20, indoor, ventilated, aluminum sheet metal chassis with 7/8" and 1" (22.22 mm and 27.76 mm) knockouts and aluminum heat sink
Maximum and Minimum Wire Size in Conduit	#6 AWG to #14 AWG (13.5 to 2.5 mm ²)
Maximum and Minimum Wire Size Rating of PV Terminal Block	#6 AWG to #14 AWG (13.5 to 2.5 mm ²)
Maximum and Minimum Wire Size Rating of Battery Terminal Block	#2 AWG to #14 AWG (35 to 2.5 mm ²)
Wire Size Rating of Auxiliary Output Connector	#16 AWG (1.5 mm ²)
Operating Temperature Range (derate above 45 °C)	-4 to 149 °F (-20 to +65 °C) (output power to be derated linearly to zero at 65 °C)
Storage Temperature	-40 to 185 °F (-40 to +85 °C)
Altitude Limit (operating)	Sea level to 6,500 feet (approximately 2000 m)
Dimensions (H × W × D)	30 × 8 5/8 × 8 5/8" (760 × 220 × 220 mm)
Mounting	Vertical wall mount
Weight (charge controller only)	29.8 lb (13.5 kg)
Weight (shipping)	38.3 lb (17.4 kg)

Output Power Versus Ambient Temperature

Once the charge controller's heat sink reaches maximum full-power operating temperature, the charge controller reduces its power output to ensure component ratings are not exceeded.

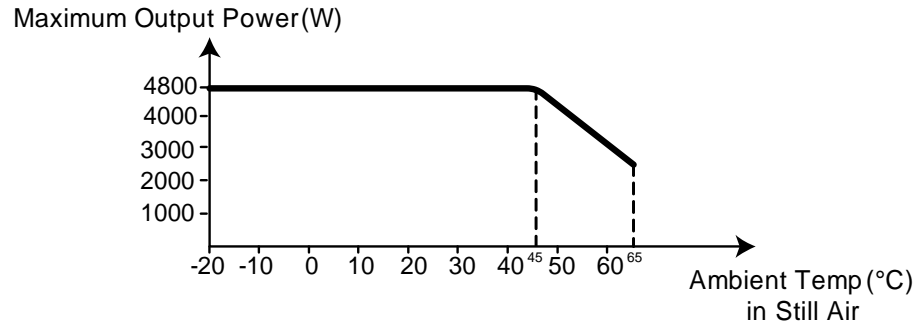

Figure A-4 Output power vs. ambient temperature

Accessories

The SCP (865-1050) is required for installation of the charge controller, and it is strongly recommended for continued operation of the charge controller. It is the primary interface to the charge controller. It must be used for setup and configuration, and it is recommended to be used for monitoring and fault reporting once installation is complete. Only one SCP is required to monitor multiple charge controllers.

NOTICE

You must use an SCP with firmware version 1.05.00 or higher for full compatibility with the charge controller. For information on updating your firmware, contact customer service. The Xantrex XW Config tool is required for upgrading.

The following accessories are optional:

Gateway	865-1055
Xanbus power supply	865-1057
XW Config (Provides the ability to update system firmware and monitor system status. See "Xantrex XW Config User's Guide" Part Number 975-0365-01-01)	865-1155

Regulatory Approvals

Certified to UL 1741 and to CSA 107.1 and carries the c(CSA)us mark.

EMC - North America:

- FCC Part-15 sub part B, Class B
- Industry Canada ICES-003, Class B

CE Marked and complies with the following:

Low Voltage Directive 2006/95/EC, per:

- EN50178 *Electronic Equipment for Use in Power Installations.*

EMC Directive 2004/108/EC, per:

- EN61000-6-3 *Emission standard for residential, commercial, and light-industrial environments*
- EN61000-6-1 *Immunity for residential, commercial, and light-industrial environments*

B

Xantrex XW System Control Panel Menus

Appendix B is a guide to the charge controller's monitoring and configuration menus on the Xantrex XW System Control Panel.

For information on:	See:
"Using the SCP"	page B-2
"The Setup Menu"	page B-6
"Configuration Settings"	page B-7
"Monitoring the Unit"	page B-10

Using the SCP

The charge controller is configured using the SCP. The SCP has four buttons for navigating between screens and menus and configuring the charge controller. See Figure B-1 and Table B-1.

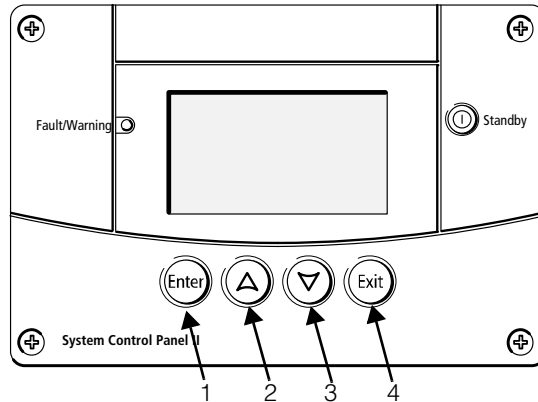

Figure B-1 SCP

Table B-1 SCP navigation buttons

Number	Button	Function
1	Enter	<ul style="list-style-type: none"> • Confirms selection of a menu item • Displays the next screen
2	Up arrow	<ul style="list-style-type: none"> • Scrolls up one line of text • Increases a selected value • Displays the previous Device Home screen
3	Down arrow	<ul style="list-style-type: none"> • Scrolls down one line of text • Decreases a selected value • Displays the next Device Home screen
4	Exit	<ul style="list-style-type: none"> • Cancels selection of a menu item • Displays the previous screen

SCP Menu Map

Figure B-2 shows how the SCP screens and menus are organized. The screens and menus are described in Table B-2.

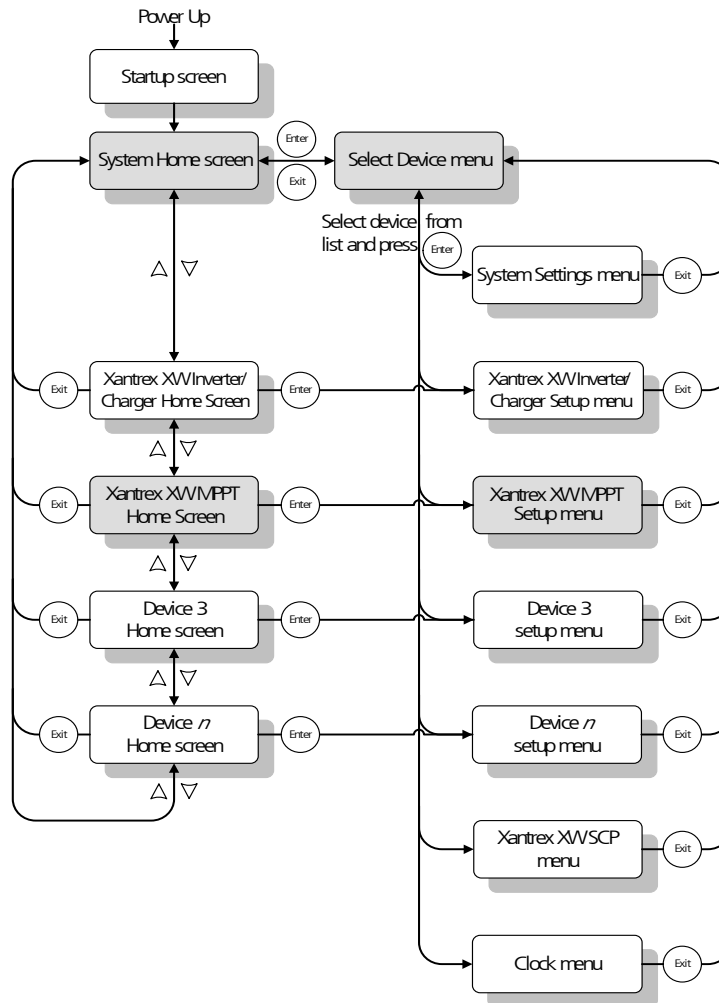

Figure B-2 SCP menu map

Table B-2 Screen and menu descriptions

Screen or menu	Description
Startup screen	Appears for a few seconds after the system starts up or when the system has been reset.
System Status screen	Displays status information for the power system, consisting of all Xanbus-connected devices on a single network. The <code>System Status</code> home screen appearance varies with the status of the inverter/charger and other Xanbus-enabled devices in the power system. The <code>System Status</code> home screen features a menu arrow pointing to the Enter button. Pressing Enter takes you to the <code>Select Device</code> menu.
XW MPPT Home screen	Displays status information for the charge controller.
Select Device menu	Displays a list of Xanbus-enabled devices in the system, including the charge controller and the SCP. The length of this menu depends on how many Xanbus-enabled devices are installed in the system. This menu also contains the clock menu (where you can set the time and date) and the system settings menu (where you can change system modes). The <code>System Panel</code> , <code>Clock</code> , and <code>System Settings</code> menu items are available from the <code>Select Device</code> menu, regardless of the number of Xanbus-enabled devices installed.
XW MPPT Setup menu	Displays status information and changeable settings. Changeable settings are identified by square brackets [] around values in the right-hand column.

Changing Settings Using the SCP

To change a charge controller's setting, use the buttons on the SCP to perform three basic steps:

1. View the `Select Device` menu.
2. Select the charge controller from the `Select Device` menu.
3. Select and adjust a changeable setting on the charge controller's `Setup` menu. See page B-8.

Each of these three steps is described in detail in the following sections.

NOTICE

You can also view the charge controller's <code>Setup</code> menu by pressing Enter from the charge controller's home screen. See "Home Screen" on page B-10.

Viewing the Select Device Menu

The `Select Device` menu is where you select a Xanbus-enabled device to monitor or configure. The number of items on the `Select Device` menu depends on how many devices are installed in your Xanbus system.

To view the Select Device menu:

- ◆ On the `System Status` screen, press Enter.

NOTICE

You can identify the `System Status` home screen by the menu arrow in the bottom left corner of the screen. The menu arrow indicates the Enter button on the SCP, which you press to view the `Select Device` menu.

Viewing the Setup Menu

On the `Select Device` menu, select the charge controller to view and change its settings.

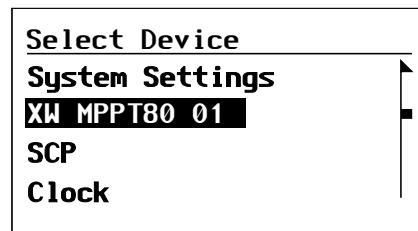

Figure B-3 Selecting the unit

To select the charge controller from the Select Device menu:

1. Press the down arrow button to highlight `XW MPPT80 xx`, where `xx` is the device number.
2. Press Enter.

The setup menu appears.

The Setup Menu

The Setup menu allows access to the `Meters` screen and several other commands that control the charge controller's operation.

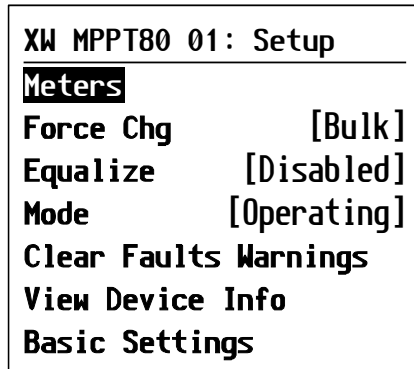

Figure B-4 Setup menu

Table B-3 Setup menu

Menu Item	Description
Meters	Displays the <code>Meters</code> screen.
Harvest Logs	Displays the charge controller's daily, monthly, and yearly performance logs. See "Viewing Harvest Logs" on page 3–11.
Force Chg	Causes the current charge stage to change to the selected stage.
Equalize	Starts or stops battery equalization.
Mode	Sets the charge controller's operating mode.
Clear Faults Warnings	Clears any active faults or warnings. If the fault or warning condition is still present, the fault or warning message could reappear.
View Device Info	Displays the <code>Dev Info</code> screen. On the <code>Dev Info</code> screen you can view the warning, fault, and event logs.
Basic Settings	Displays the charge controller's basic or advanced configuration settings. To change to advanced settings, press the Enter, up arrow, and down arrow buttons simultaneously.

Configuration Settings

The configuration settings can be viewed in basic and advanced formats.

Basic menu

The basic menu contains items you might have to view and adjust on a routine basis.

Advanced menu

The advanced menu contains items intended for service personnel and one-time setup, such as auxiliary output and custom battery configuration. To display the `Advanced Settings` menu item instead of the `Basic Settings` menu item, perform the following special keypress::

- ◆ From the `Setup` menu, press the `Enter`, `up arrow`, and `down arrow` buttons simultaneously.

On the `Setup` menu, `Basic Settings` disappears from the bottom of the list, and `Advanced Settings` appears at the top of the list.

After configuring the charge controller, help prevent unintended advanced configuration by using the combined keypress again to hide the advanced menu items.

NOTICE

- This keypress displays advanced settings for every device in the system.
- After performing the keypress, `Advanced Settings` appears at the top of the `Setup` menu. When the keypress is performed again, the `Setup` menu displays `Basic Settings` as the last item on the menu.

The charge controller's `Config` menu contain sub-menus for configuring:

- Multiple-unit operation
- Charger and battery settings
- Input settings
- Auxiliary output settings.

To view the `Config` menu:

- ◆ From the `Setup` menu, with `Basic Settings` or `Advanced Settings` highlighted, press `Enter`.

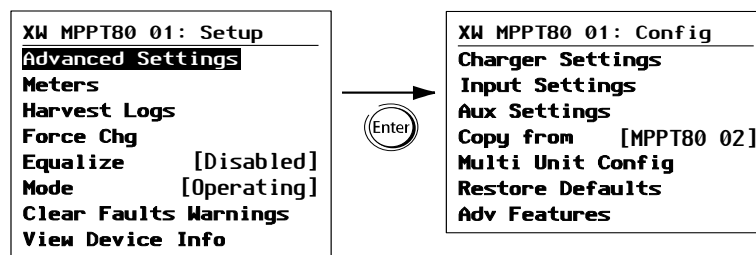

Figure B-5 Selecting the configure menu

For a map of all configuration menus, see Figure B-7 on page B-9.

Configurable settings are identified by square brackets [] around the values along the right side of the screen.

To select and change a configurable setting:

1. On the menu, press the up arrow or down arrow button to highlight the setting you want to change.
2. Press Enter to highlight the current value of the setting.
3. Press the up arrow or the down arrow button to change the value. Hold down the button to scroll through a large range of values quickly.
The previously set value appears with an asterisk (*) beside it.
4. Press Enter to select the value.

To restore the charge controller's default settings:

1. On the Config menu, select Restore Defaults.
2. Press Enter.

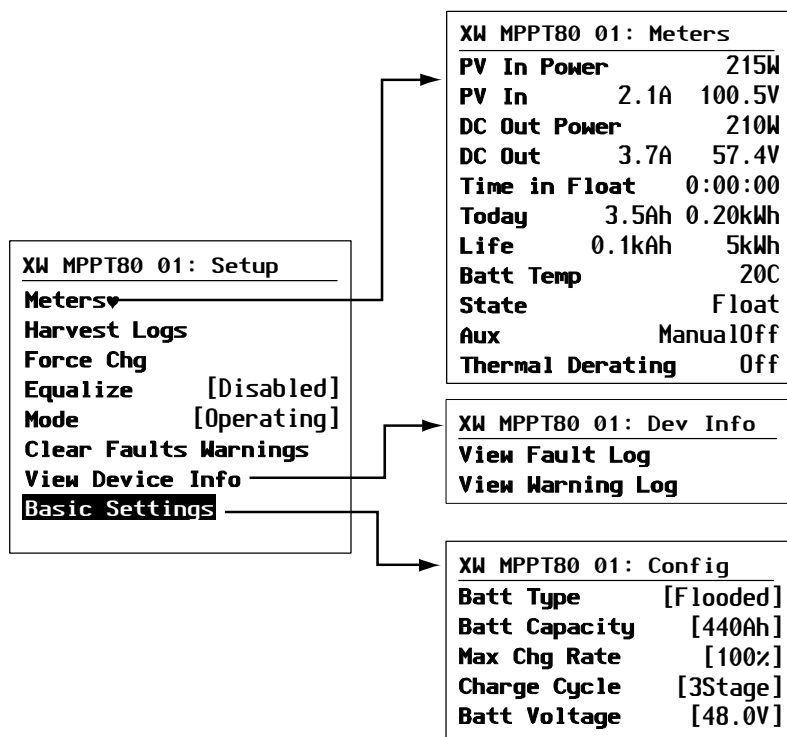

Figure B-6 Configuration menus (Basic)

Monitoring the Unit

You can monitor the charge controller's operation on the SCP by viewing the:

- Home screen
- Meters screen

Home Screen

The charge controller's Home screen displays real-time operational data specific to the charge controller.

To view the charge controller's Home screen:

- ◆ From the `System Status` screen, press the down arrow until the charge controller's Home screen appears.

To return to the System Status screen:

- ◆ Press the Exit button.

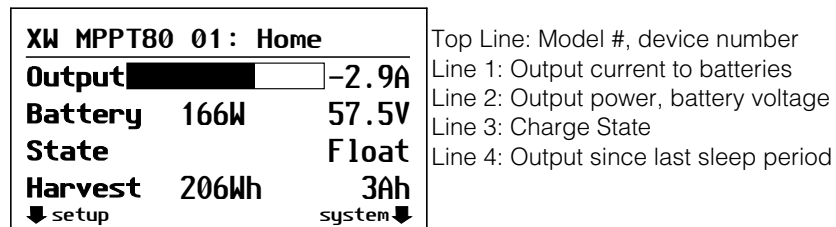

Figure B-8 Home screen

The charge controller's Home screen features a `setup` arrow pointing to the Enter button and a `system` arrow pointing to the Exit button. Pressing Enter takes you to the charge controller's Setup menu. Pressing Exit takes you to the `System Status` screen.

Pressing the down arrow button takes you to the home screens for the other Xanbus-enabled devices in the system.

Meters

Monitor the charge controller's operation on the **Meters** screen. The **Meters** screen displays input and output power, battery temperature, charge stage, total power production for that day, and power production over the charge controller's lifetime.

You can select the **Meters** screen from the charge controller's **Setup** menu.

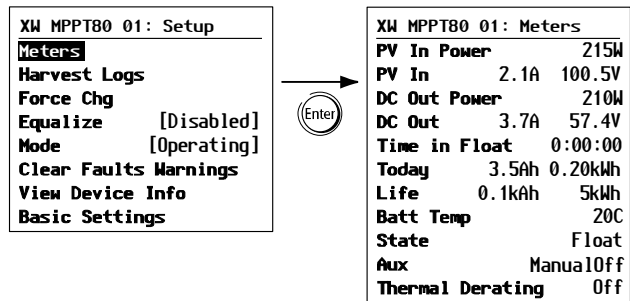

Figure B-9 Selecting the Meters screen

C

Boost Charging

Appendix C provides information on Boost Charging for flooded lead-acid batteries in off-grid applications.

Using Boost Charging

Boost charging allows for better utilization of flooded lead acid batteries under moderate cycling in off grid applications. Boost charging encourages a short duration charging voltage—above the gassing voltage—at the beginning of the absorption charge state. Testing has shown that boost charging improves battery performance by providing a regular mixing of the liquid electrolyte. Boost charging specifically discourages capacity-robbing acid stratification and plate sulfation.

Boost mode charging can be enabled by selecting the custom battery type and then setting the bulk voltage higher than the absorption voltage. The multi-stage charge algorithm then attempts to use the higher bulk voltage for the first hour of the absorption stage – unless interrupted by the max absorption timer or exit current threshold mechanism.

1. Boost charging encourages gassing of flooded lead acid batteries.

⚠ WARNING

HAZARD OF EXPLOSION

Boost charging generates explosive gases which might escape from the battery. Always make sure battery ventilation is adequate.

Failure to follow these instructions can result in death or serious injury.
--

2. Boost charging is NOT recommended for AGM, GEL, or any other electrolyte-limited and/or valve regulated sealed battery application.
3. Boost charging could result in higher than normal water consumption. However, the benefits of boost charging are likely to be greater than the extra watering effort. Check battery water levels at least once per month.
4. Boost charging has maximum benefit when used on batteries that experience moderate cycling. An unoccupied cottage, for example, where batteries are full the majority of the time, might not benefit from boost charging – especially if battery watering is difficult.

Index

A

- abbreviations v
- Absorb Time setting 2–5
- Absorb Voltage setting 2–6
- absorption charging stage 1–4, 3–4
- accessories A–6
- acronyms v
- advanced settings
 - menu map B–9
 - viewing 2–2
- alarm using auxiliary output 1–9
- ambient temperature versus output power A–6
- amp-hour capacity, batteries 2–5
- auxiliary output
 - alarm application 1–9
 - configuring 2–8
 - load control application 1–9
 - overview 1–9
 - trigger source configurable ranges 2–12
 - trigger source descriptions 2–11
 - vent fan application 1–9

B

- Batt Capacity setting 2–5
- Batt Temp setting 2–5
- Batt Type setting 2–4
- Batt Voltage setting 2–4
- batteries
 - amp-hour capacity 2–5
 - boost charging C–2
 - configuring 2–3
 - custom 2–6
 - default charger settings A–5
 - equalization. *See* equalization
 - safety information viii
 - stopping equalization manually 3–14
- battery temperature compensation
 - BTS not connected 2–5
 - overview 1–7, 2–7
- battery temperature sensor 1–7
- BattTempComp setting 2–6
- boost charging C–2
- bulk charging stage 1–4, 3–4
- Bulk Voltage setting 2–6

C

- CAUTION, definition iv
- charge controlling
 - absorption charging stage 1–4, 3–4
 - boost charging C–2
 - bulk charging stage 1–4, 3–4
 - charging current 1–4
 - equalize charging stage 3–4
 - float charging stage 1–5, 3–4
 - manually advance stages 2–5
 - no charge charging stage 3–4
 - no float charging stage 1–6, 3–4
 - overview 1–4
 - three-stage diagram 1–5
 - three-stage overview 1–4
 - two-stage diagram 1–7
 - two-stage overview 1–6
- Charge Cycle setting 2–5
- charge stages 3–4
- charger settings, default A–5
- Clear Delay setting 2–10
- Clear Level setting 2–10
- configurable settings, modifying 2–3
- Copy from setting 2–14
- copying settings 2–14
- custom batteries, setting 2–6

D

- daily logs 3–12
- DANGER, definition iv
- DC Conn setting 2–4
- Default Batt Temp setting 2–5
- default settings, resetting to 2–16, B–8
- Dev Number setting 2–13
- device settings 2–13
- disabling power supplies at night 2–16
- down arrow button, Xantrex XW System Control Panel B–2

E

- electrical specifications A–2
- enter button, Xantrex XW System Control Panel B–2
- Eqlz Support setting 2–6
- Eqlz Voltage setting 2–6

equalization

- charging stage 3–4
- determining when complete 3–14
- enabling 3–14
- overview 1–8, 3–12
- stopping manually 3–14

equalize LED 3–2

Equalize setting 2–4

error/warning LED 3–2

errors

- clear manually 3–5
- messages 3–7
- overview 3–4
- viewing active 3–5
- viewing logs 3–11

exit button

- Xantrex XW System Control Panel B–2

F

F/W Rev setting 2–13

Fast Sweep 1–3

faults

- clear manually 3–5
- disable normal operation 3–5
- messages 3–6
- must be manually cleared 3–5
- overview 3–4
- viewing active 3–5
- viewing logs 3–11

faults and warnings menu 3–4

FCC information ix

float charging stage 1–5, 3–4

Float Voltage setting 2–6

Force Chg setting 2–5

GGateway. *See* Xantrex Gateway

green LED 3–2

H

harvest logs

- daily 3–12
- monthly 3–12
- overview 3–11
- requirements 3–11
- yearly 3–12

I

input, configuring 2–7

interference, radio and television reception ix

L

LEDs

- flashing 3–2
- overview 3–2

limitations on use vii

Lo Pwr at Night setting 2–16

load control using auxiliary output 1–9

logs

- daily 3–12
- error 3–11
- fault 3–11
- harvest 3–11
- monthly 3–12
- warning 3–11
- yearly 3–12

M

Manual Aux setting 2–9

manually

- advancing charge stages 2–5
- clearing faults, errors, or warnings 3–5

Max Chg Rate setting 2–5

maximum power point tracking

- maximum power point curve 1–3
- overview 1–3
- voltage range A–3

mechanical specifications A–5

menu mapsXantrex XW System Control Panel

- advanced configuration menu map B–9

messages

- errors 3–7
- faults 3–6
- warnings 3–9

meters screen B–11

Mode setting 2–13

monthly logs 3–12

MPPT AutoTrack setting 2–8

MPPT Ref Volts setting 2–8

MPPT. *See* maximum power point tracking

multiple units, copying settings 2–14

N

NetPS Night Dis setting 2–16

nighttime tare losses 2–16

no float charging stage 1–6, 3–4

not charging, charging stage 3–4

NOTICE, definition iv

O

on/charging LED 3-2
 Operating mode 2-13
 operating mode, configuring 2-13
 orange LED 3-2
 output power versus ambient temperature A-6

P

peak power tracking, configuring 2-7
 personal protection viii
 power supplies, disabling at night 2-16
 protection, personal viii
 PV In setting 2-8

R

radio reception interference ix
 reception interference ix
 ReCharge Volts setting 2-5
 red LED 3-2
 regulatory approvals A-7
 resetting to factory defaults 2-16, B-8
 Restore Defaults setting 2-16

S

safety information
 batteries viii
 general vii
 SCP. *See* Xantrex XW System Control Panel
 settings
 Absorb Time 2-5
 Absorb Voltage 2-6
 Batt Capacity 2-5
 Batt Temp 2-5
 Batt Type 2-4
 Batt Voltage 2-4
 BattTempComp 2-6
 Bulk Voltage 2-6
 Charge Cycle 2-5
 Clear Delay 2-10
 Clear Level 2-10
 Copy from 2-14
 DC Conn 2-4
 Default Batt Temp 2-5
 Dev Number 2-13
 EqIz Support 2-6
 EqIz Voltage 2-6
 Equalize 2-4
 F/W Rev 2-13
 Float Voltage 2-6
 Force Chg 2-5

Lo Pwr at Night 2-16
 Manual Aux 2-9
 Max Chg Rate 2-5
 Mode 2-13
 MPPT AutoTrack 2-8
 MPPT Ref Volts 2-8
 NetPS Night Dis 2-16
 PV In 2-8
 ReCharge Volts 2-5
 Restore Defaults 2-16
 Trig Src 2-9
 Trigger Delay 2-10
 Trigger Level 2-10
 shade tolerance 1-3
 specifications
 electrical A-2
 mechanical A-5
 Standby mode 2-13
 status information
 charge stages 3-4
 LEDs 3-2
 normal operation 3-3
 unit 3-2
 Xantrex XW System Control Panel 3-3
 stopping battery equalization 3-14

T

tare losses, reducing 2-16
 television reception interference ix
 three-stage charge controlling
 diagram 1-5
 overview 1-4
 Trig Src setting 2-9
 Trigger Delay setting 2-10
 Trigger Level setting 2-10
 trigger source
 configurable ranges 2-12
 descriptions 2-11
 troubleshooting 4-2
 two-stage charge controlling
 diagram 1-7
 overview 1-6

U

up arrow button, Xantrex XW System Control Panel
 B-2

V

vent fan using auxiliary output 1-9

W

WARNING, definition iv

warnings

- clear manually 3–5
- messages 3–9
- overview 3–4
- viewing active 3–5
- viewing logs 3–11

X

Xantrex Gateway 1–2

Xantrex Xanbus

- disabling at night 2–16

Xantrex XW System Control Panel





- advanced settings display 2–2
- auxiliary output configuration 2–8
- basic configuration menu map B–8
- basic settings 2–2
- battery configuration 2–3
- buttons B–2
- changing settings B–4
- configurable settings 2–3
- custom battery type settings 2–6
- device settings configuration 2–13
- disabling power supplies at night 2–16
- down arrow button B–2
- enter button B–2
- error messages 3–7
- exit button B–2
- fault messages 3–6
- input configuration 2–7
- meters screen B–11
- operating mode configuration 2–13
- peak power tracking configuration 2–7
- reducing tare losses 2–16
- selecting a unit 2–2
- startup screen B–4
- status information 3–3
- system home screen B–4
- up arrow button B–2
- warning messages 3–9
- XW MPPT80 600 home screen B–10

Y

yearly logs, viewing 3–12

Schneider Electric

www.schneider-electric.com

			
North America	1 650 351 8237 1 866 519 1470	1 925 245 1022	re.techsupport@schneider-electric.com
France	+33 (0) 825 012 999		fr-re-techsupport@fr.schneider-electric.com
Deutschland	+49 (0) 180 575 3 575	+49 (0) 2102 404 7101	pv-service@de.schneider-electric.com
España	+34 902 101 813	+34 933 055 026	es-sat@es.schneider-electric.com
L'Italia	+39 035 4151111	+39 035415 3200	IT-pronto-contatto@it.schneider-electric.com

For other country details please contact your local Schneider Electric Sales Representative or visit the Schneider Electric website at:
<http://www.schneider-electric.com/sites/corporate/en/support/operations/local-operations/local-operations.page>.